

Register your instrument!
www.eppendorf.com/myeppendorf



Centrifuge 5702/5702 R/ 5702 RH

Operating Manual

Copyright © 2021 Eppendorf SE, Germany. All rights reserved, including graphics and images. No part of this publication may be reproduced without the prior permission of the copyright owner.

Centriplus® is a registered trademark of Millipore Corporation, USA.

CombiSlide® is a registered trademark of Eppendorf SE, Germany.

Eppendorf® and the Eppendorf Brand Design are registered trademarks of Eppendorf SE, Germany.

Registered trademarks and protected trademarks are not marked in all cases with ® or ™ in this manual.

U.S. Patents are listed on www.eppendorf.com/ip.

Table of contents

1	Operating instructions	7
1.1	Using this manual	7
1.2	Danger symbols and danger levels	7
1.2.1	Danger symbols	7
1.2.2	Danger levels	7
1.3	Symbols used	8
1.4	Abbreviations used	8
2	Safety	9
2.1	Intended use	9
2.2	User profile	9
2.3	Application limits	9
2.4	Warnings for intended use	10
2.4.1	Personal injury or damage to device	10
2.4.2	Incorrect handling of the centrifuge	12
2.4.3	Incorrect handling of the rotors	12
2.4.4	Extreme strain on the centrifugation tubes	13
2.5	Safety instructions on the device	14
2.6	Obligation to report accidental damage or damage to the device	15
2.6.1	Manufacturer Eppendorf SE	15
2.6.2	Local Eppendorf distributor	15
3	Product description	17
3.1	Product overview	17
3.1.1	Centrifuge 5702	17
3.1.2	Centrifuge 5702 R / RH	18
3.2	Delivery package	19
3.3	Features	20
3.4	Name plate	21
4	Installation	23
4.1	Selecting the location	23
4.2	Preparing installation	24
4.3	Installing the instrument	25
5	Operation	27
5.1	Operating controls	27
5.2	Switching on the centrifuge	30
5.3	Replacing the rotor	30
5.3.1	Inserting the rotor	30
5.3.2	Removing the rotor	30
5.4	Loading a fixed-angle rotor	31
5.5	Loading a swing-bucket rotor	31
5.5.1	Inserting the bucket in the swing-bucket rotor	32
5.5.2	Performing an imbalance calibration	32
5.5.3	Loading buckets symmetrically	33
5.6	Closing the centrifuge lid	35

Table of contents

Centrifuge 5702/5702 R/5702 RH
English (EN)

5.7	Using the timer function	35
5.7.1	Accessing the timer menu	35
5.7.2	Setting and activating the timer	36
5.7.3	Deleting the timer interval	36
5.7.4	Deactivating the activated timer	36
5.7.5	Canceling the activated timer	37
5.8	Centrifugation	37
5.8.1	Centrifugation with time setting	37
5.8.2	Centrifuging in continuous operation	38
5.8.3	Short run centrifugation	39
5.8.4	Setting the soft ramp	39
5.8.5	Setting the start of the time counting (At set rpm function)	40
5.8.6	Calculating the speed of centrifugation	40
5.9	Centrifuge 5702 R, Centrifuge 5702 RH: Heating and cooling	41
5.9.1	Setting the temperature	41
5.9.2	Temperature display	41
5.9.3	Temperature monitoring	41
5.9.4	Temperature control run FastTemp	42
5.9.5	Continuous cooling	43
5.9.6	Centrifuge 5702 RH: Temperature profiles	43
5.10	Information on aerosol-tight centrifugation	44
5.10.1	Aerosol-tight centrifugation in a fixed-angle rotor	44
5.11	Switching off the centrifuge	45
6	Device settings	47
6.1	Changing the operating state	47
6.2	Key lock	47
6.2.1	Centrifuge 5702 R, Centrifuge 5702 RH: Securing the program against changes	48
6.2.2	Centrifuge 5702: Displaying the key lock status	48
6.3	Speakers	49
6.3.1	Display the status of the speakers	49
7	Programs	51
7.1	Creating and storing a program	51
7.2	Saving the current settings as a program	51
7.3	Calling up a program	52
7.4	Editing programs	52
7.5	Deleting programs	52
7.6	Exiting the program	52
8	Maintenance	53
8.1	Service options	53
8.2	Service	53
8.3	Preparing cleaning/disinfection	53
8.4	Cleaning/disinfection	54
8.4.1	Cleaning and disinfecting the device	55
8.4.2	Cleaning and disinfecting the rotor	55

8.5	Additional care instructions for refrigerated centrifuges	56
8.6	Cleaning glass breakage	56
8.7	Replacing the fuses	57
8.8	Decontamination before shipment	57
9	Troubleshooting	59
9.1	General errors	59
9.2	Error messages	60
9.3	Emergency release	63
10	Transport, storage and disposal	65
10.1	Transport	65
10.2	Storage	65
10.3	Disposal	66
11	Technical data	67
11.1	Power supply	67
11.2	Ambient conditions	67
11.3	Weight/dimensions	68
11.4	Noise level	68
11.5	Application parameters	69
11.6	Acceleration and deceleration times	70
11.7	Service life of accessories	71
12	Rotors, tubes and adapters	73
12.1	Rotor A-4-38	73
12.1.1	Rotor A-4-38 with 4 round buckets	73
12.1.2	Rotor A-4-38 with 4 rectangular buckets	76
12.2	Rotor A-8-17	77
12.3	Rotor F-45-24-11	78
12.4	Rotor F-35-30-17	79
12.5	Rotor F-45-18-17-Cryo	80
13	Ordering Information	81
13.1	Rotor A-4-38	81
13.1.1	Rotor A-4-38 with round buckets	81
13.1.2	Rotor A-4-38 with rectangular buckets	82
13.2	Rotor A-8-17	82
13.3	Rotor F-45-24-11	83
13.4	Rotor F-35-30-17	83
13.5	Rotor F-45-18-17-Cryo	84
13.6	Fuses	84
	Certificates	85

Table of contents

Centrifuge 5702/5702 R/5702 RH
English (EN)

1 Operating instructions







1.1 Using this manual

- ▶ Read this operating manual completely before using the device for the first time. Observe the instructions for use of the accessories where applicable.
- ▶ This operating manual is part of the product. Please keep it in a place that is easily accessible.
- ▶ Enclose this operating manual when transferring the device to third parties.
- ▶ The current version of the operating manual for all available languages can be found on our webpage www.eppendorf.com/manuals.

1.2 Danger symbols and danger levels

1.2.1 Danger symbols

The safety instructions in this manual have the following danger symbols and danger levels:

	Biohazard		Explosive substances
	Electric shock		Risk of crushing
	Hazard point		Material damage

1.2.2 Danger levels

DANGER	<i>Will</i> lead to severe injuries or death.
WARNING	<i>May</i> lead to severe injuries or death.
CAUTION	May lead to light to moderate injuries.
NOTICE	May lead to material damage.

1.3 Symbols used

Depiction	Meaning
1. 2.	Actions in the specified order
▶	Actions without a specified order
•	List
<i>Text</i>	Display or software texts
i	Additional information

1.4 Abbreviations used

CE

European Community – A CE indicates that a product has been tested before being placed on the market and complies with the safety, health and/or environmental protection requirements of the European Union.

PCR

Polymerase Chain Reaction

rcf

Relative centrifugal force : g -force in m/s^2

rpm

Revolutions per minute

UV

Ultraviolet radiation

2 Safety

2.1 Intended use

The Centrifuge 5702/5702 R/5702 RH is a non-automatic centrifuge for separating liquid substance mixtures from the human body and is specifically intended for use as an accessory with an in-vitro diagnostic device in order to facilitate the in-vitro diagnostic device to be used in accordance with its intended use.

Eppendorf centrifuges are only intended for indoor use and for operation by trained and skilled personnel.

2.2 User profile

The device and accessories may only be operated by trained and skilled personnel.

Before using the device, read the operating manual and the instructions for use of the accessories carefully and familiarize yourself with the device's mode of operation.

2.3 Application limits



DANGER! Risk of explosion.

- ▶ Do not use the device in an explosive atmosphere.
 - ▶ Do not operate the device in areas where work with explosive substances is carried out.
 - ▶ Do not use the device to process any explosive or highly reactive substances.
 - ▶ Do not use the device to process any substances which could generate an explosive atmosphere.
-

Due to its design and the environmental conditions inside the device, the Centrifuge 5702/5702 R/5702 RH is not suitable for use in a potentially explosive atmosphere.

The device may only be used in a safe environment, such as in the open environment of a ventilated laboratory or a fume hood. The use of substances that could contribute to a potentially explosive atmosphere is not permitted. The final decision on the risks associated with the use of such substances is the user's responsibility.

2.4 Warnings for intended use

2.4.1 Personal injury or damage to device



WARNING! Electric shock due to damage to the device or mains/power cord.

- ▶ Only switch on the device if the device and the mains/power cord are undamaged.
- ▶ Only operate devices which have been installed or repaired properly.
- ▶ In case of danger, disconnect the device from the mains/power supply.



WARNING! Lethal voltages inside the device.

Touching high-voltage parts can cause an electric shock. Electric shocks can cause heart injury and respiratory paralysis.

- ▶ Ensure that the housing is closed and undamaged.
 - ▶ Do not remove the housing.
 - ▶ Make sure that no liquids enter the device.
- Only authorized service staff may open the device.



WARNING! Danger due to incorrect voltage supply.

- ▶ Only connect the device to voltage sources which correspond with the electrical requirements specified on the name plate.
- ▶ Only use earth/grounded sockets with a protective earth conductor.
- ▶ Only use the mains/power cord supplied.



WARNING! Damage to health due to infectious liquids and pathogenic germs.

- ▶ When handling infectious liquids and pathogenic germs, observe the national regulations, the biosafety level of your laboratory, and the manufacturers' Safety Data Sheets and application notes.
- ▶ Use aerosol-tight locking systems to centrifuge these substances.
- ▶ When working with pathogenic germs which belong to a higher risk group, more than one aerosol-tight bioseal must be used.
- ▶ Wear your personal protective equipment.
- ▶ For comprehensive regulations about handling germs or biological material of risk group II or higher, please refer to the "Laboratory Biosafety Manual" (source: World Health Organization, Laboratory Biosafety Manual, in the currently valid version).



WARNING! Risk of injury when opening or closing the centrifuge lid.

There is a risk of crushing your fingers when opening or closing the centrifuge lid.

- ▶ Do not reach between the device and centrifuge lid when opening or closing the centrifuge lid.
- ▶ Do not reach into the locking mechanism of the centrifuge lid.
- ▶ Open the centrifuge lid fully to ensure that the centrifuge lid cannot slam shut.



WARNING! Risk of injury from rotating rotor.

If the emergency release of the lid is operated, the rotor may continue to rotate for several minutes.

- ▶ Wait for the rotor to stop before activating the emergency release.
- ▶ To check, look through the monitoring glass in the centrifuge lid.



WARNING! Risk of injury from chemically or mechanically damaged accessories.

Even minor scratches and cracks can lead to severe internal material damage.

- ▶ Protect all accessory parts from mechanical damage.
- ▶ Inspect the accessories for damage before each use. Replace any damaged accessories.
- ▶ Do not use any accessories which have exceeded their maximum service life.



CAUTION! Poor safety due to incorrect accessories and spare parts.

The use of accessories and spare parts other than those recommended by Eppendorf may impair the safety, functioning and precision of the device. Eppendorf cannot be held liable or accept any liability for damage resulting from the use of accessories and spare parts other than those recommended or from improper use.

- ▶ Only use accessories and original spare parts recommended by Eppendorf.



NOTICE! Damage to the device due to spilled liquids.

1. Switch off the device.
2. Disconnect the device from the mains/power supply.
3. Carefully clean the device and the accessories in accordance with the cleaning and disinfection instructions in the operating manual.
4. If a different cleaning and disinfection method is to be used, contact Eppendorf SE to ensure that the intended method will not damage the device.



NOTICE! Damage to electronic components due to condensation.

Condensate may form in the device when it has been transported from a cool environment to a warmer environment.

- ▶ After installing the device, wait for at least 3 h. Only then connect the device to the mains/power line.

2.4.2 Incorrect handling of the centrifuge

**NOTICE! Damage from knocking against or moving the device during operation.**

If the rotor hits the rotor chamber wall, it will cause considerable damage to the device and rotor.

- ▶ Do not move or knock against the device during operation.
-

2.4.3 Incorrect handling of the rotors

**WARNING! Risk of injury from improperly attached rotors and rotor lids.**

- ▶ Only centrifuge with the rotor and rotor lid firmly tightened.
 - ▶ If any unusual noises occur when the centrifuge starts, the rotor or the rotor lid may not be attached properly. Stop the centrifugation immediately.
-

**CAUTION! Risk of injury due to asymmetric loading of a rotor.**

- ▶ Load rotors symmetrically with identical tubes.
 - ▶ Only load adapters with suitable tubes.
 - ▶ Always use the same type of tubes (weight, material/density and volume).
 - ▶ Use a balance to check that the load is symmetrical by balancing the adapters and tubes that are used.
-

**CAUTION! Risk of injury from overloaded rotor.**

The centrifuge is designed for the centrifugation of material with a maximum density of 1.2 g/mL at maximum speed and filling volume and/or load.

- ▶ Do not exceed the maximum load of the rotor.
-

**NOTICE! Damage to rotors from aggressive chemicals.**

Rotors are high-quality assemblies which withstand extreme stresses. This stability can be impaired by aggressive chemicals.

- ▶ Avoid using aggressive chemicals such as strong and weak alkalis, strong acids, solutions with mercury ions, copper ions and other heavy metal ions, halogenated hydrocarbons, concentrated saline solutions and phenol.
- ▶ If it is contaminated by aggressive chemicals, clean the rotor and especially the rotor bores immediately using a neutral cleaning agent.
- ▶ Due to the manufacturing process, color variations may occur on PTFE coated rotors. These color variations do not affect the service life or resistance to chemicals.



NOTICE! If handled incorrectly, the rotor may fall.

The swing-bucket rotor may fall if the buckets are used as handles.

- ▶ Remove the buckets before inserting and/or removing a swing-bucket rotor.
 - ▶ Always use both hands to carry the rotor cross.
-

2.4.4 Extreme strain on the centrifugation tubes



CAUTION! Risk of injury from overloaded tubes.

- ▶ Note the loading limits specified by the tube manufacturer.
 - ▶ Only use tubes which are approved by the manufacturer for the required *g*-forces (rcf).
-



NOTICE! Danger from damaged tubes.

Damaged tubes must not be used, as this could cause further damage to the device and the accessories and loss of the samples.

- ▶ Visually check all tubes for damage before use.



NOTICE! Danger due to deformed or brittle material. Autoclaving at excessively high temperatures can lead to plastic tubes, adapters and rotor lids becoming brittle and deformed.

This could result in damage to the device and the accessories and sample loss.

- ▶ Observe the temperatures specified by the manufacturer when autoclaving tubes.
- ▶ Do not use any deformed or brittle tubes.



NOTICE! Danger from open tube lids.

Open tube lids may break off during centrifugation and damage both the rotor and the centrifuge.

- ▶ Carefully seal all tube lids before centrifuging.



NOTICE! Damage to plastic tubes due to organic solvents.





The density of plastic tubes is reduced when organic solvents (e.g., phenol, chloroform) are used, i.e. the tubes may become damaged.

- ▶ Note the manufacturer's information on the chemical resistance of the tubes.
-

Safety

Centrifuge 5702/5702 R/5702 RH
English (EN)

2.5 Safety instructions on the device

Symbol	Meaning	Location
	NOTICE ▶ Observe the safety instructions in the operating manual.	Rear of the device
	▶ Observe the operating manual.	
	• Warning: Possible hand injury	Upper side of the device, under the centrifuge lid.
	▶ Always tighten the rotor with the enclosed rotor key.	Upper side of the device, under the centrifuge lid.
	Warning of biological risks when handling infectious liquids or pathogenic germs.	Aerosol-tight fixed-angle rotors: rotor lid Aerosol-tight buckets: cap

2.6 Obligation to report accidental damage or damage to the device

As the operator of a medical device, you are obliged to report serious accidents or injuries to persons caused by our device to the following authorities:

- The competent local authorities
- Eppendorf SE
- Your local Eppendorf distributor

2.6.1 Manufacturer Eppendorf SE

Eppendorf SE

Barkhausenweg 1

22339 Hamburg

GERMANY

eppendorf@eppendorf.com

2.6.2 Local Eppendorf distributor

<https://www.eppendorf.com/contact>

Safety

Centrifuge 5702/5702 R/5702 RH
English (EN)

3 Product description
3.1 Product overview
3.1.1 Centrifuge 5702

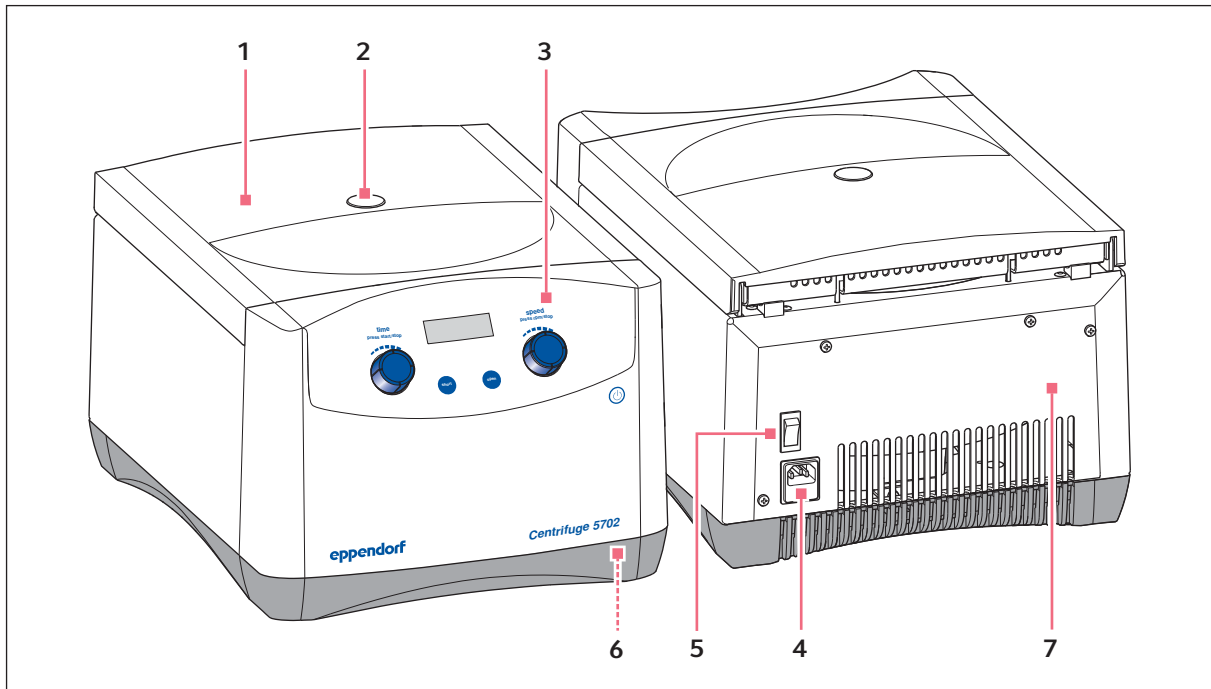

Fig. 3-1: Centrifuge 5702

- | | |
|---|--|
| 1 Centrifuge lid | 5 Mains/power switch
Switch for switching the centrifuge on and off. |
| 2 Monitoring glass
Visual inspection for rotor stop and/or facility for a speed check using a stroboscope | 6 Emergency release |
| 3 Control panel
Display, rotary knobs and keys for operating the centrifuge | 7 Name plate |
| 4 Mains/power cord socket
Connection for the mains/power cord supplied | |

Product description

Centrifuge 5702/5702 R/5702 RH
English (EN)

3.1.2 Centrifuge 5702 R / RH

Fig. 3-2: Centrifuge 5702 R / RH

- | | |
|---|---|
| <p>1 Centrifuge lid</p> <p>2 Monitoring glass
Visual inspection for rotor stop and/or facility for a speed check using a stroboscope.</p> <p>3 Control panel
Display, rotary knobs and keys for operating the centrifuge.</p> <p>4 Mains/power cord socket
Connection for the mains/power cord supplied</p> | <p>5 Mains/power switch
Switch for switching the centrifuge on and off.</p> <p>6 Emergency release</p> <p>7 Name plate</p> <p>8 Condensation water tray
For collecting the condensation water from the device</p> |
|---|---|

3.2 Delivery package

1	Centrifuge 5702/5702 R/5702 RH
1	Rotor key
1	Mains/power cord
1	Instructions
1	Set of fuses

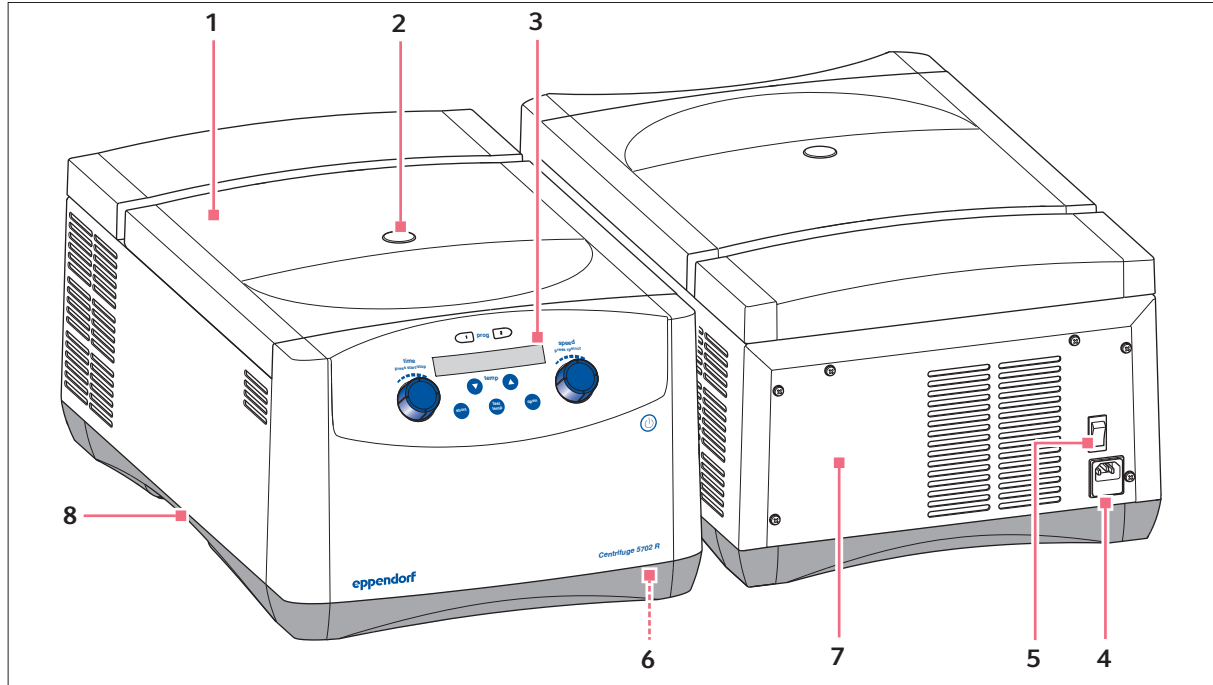

- ▶ Check that the delivery is complete.
- ▶ Check all parts for transport damage.
- ▶ To safely transport and store the device, retain the transport box and packing material.

Product description

Centrifuge 5702/5702 R/5702 RH
English (EN)

3.3 Features

The low-speed centrifuge family 5702 has been especially developed for cell culture laboratories and clinical research laboratories with a low to medium throughput. Due to their compact design these centrifuges fit on nearly all types of lab bench and their quiet operation improves your work environment. They can be operated with six different rotor options to accommodate nearly all types of tubes.

The right model for your application:

- Centrifuge 5702 for standard applications
- Cooled model Centrifuge 5702 R for samples which are sensitive to heat
- The cooled and heated model Centrifuge 5702 RH enables centrifuging in the area of molecular biology, improves the viability of the cells, resulting in more accurate results in subsequent applications (e.g. for cell cultivation).

Product features

- Maximum speed: 3000 × *g* (4 400 rpm)
- Very compact footprint – fits on any lab bench
- Very quiet operation for a better work environment
- Low height of the device makes loading and unloading of samples easier
- SOFT braking function for slow acceleration and braking. Optimized for cell separation using gradient centrifugation
- At set rpm function to start the timer when the selected speed has been reached; for reproducible centrifugation
- Timer function to start the centrifugation run at a later time
- Key lock prevents unintentional adjustments
- Stainless steel rotor chamber is rust-proof and easy to clean
- Electronic imbalance detection for maximum safety

Special features of Centrifuge 5702 R and Centrifuge 5702 RH

- Centrifuge 5702 R: Temperature settings from -9 °C to 40 °C
- Centrifuge 5702 RH: Temperature settings from -9 °C to 42 °C
- FastTemp function for fast precooling
- Continuous cooling maintains the set temperature of the Centrifuge 5702 R even when the lid is closed
- ECO switch-off function is activated after 8 hours without any operation to reduce energy consumption and to extend the life of the compressor
- Two program keys for storing routine runs
- Active heating ensures high temperature accuracy during the entire centrifugation (Centrifuge 5702 RH only)

3.4 Name plate

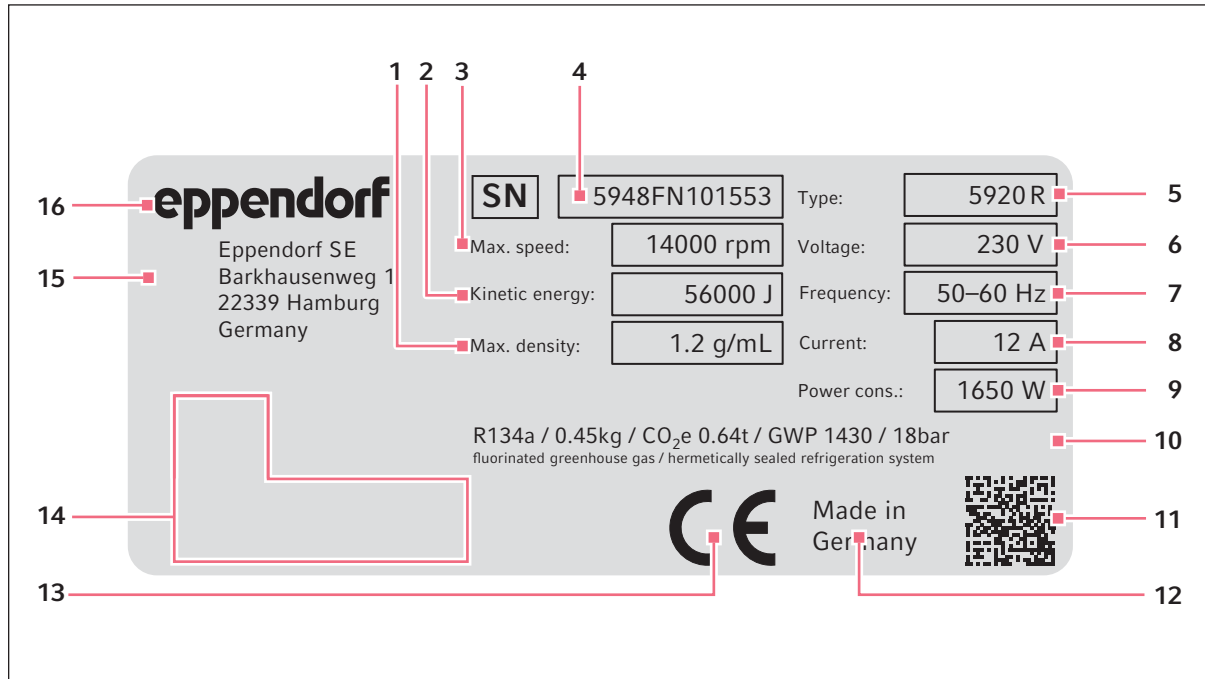









Fig. 3-3: Eppendorf SE device identification (example)

- | | |
|---|--|
| 1 Maximum density of the material for centrifuging | 9 Maximum rated power |
| 2 Maximum kinetic energy | 10 Information on the refrigerant (refrigerated centrifuges only) |
| 3 Maximum speed | 11 Data matrix code for serial number |
| 4 Serial number | 12 Designation of origin |
| 5 Product name | 13 CE marking |
| 6 Rated voltage | 14 Certification marks and symbols (device-specific) |
| 7 Rated frequency | 15 Manufacturer's address |
| 8 Maximum rated current | 16 Manufacturer |

Product description

Centrifuge 5702/5702 R/5702 RH
English (EN)

Tab. 3-1: Certification marks and symbols (device-specific)

Symbol/certification mark	Meaning
	Serial number
	Manufacturer
	In-vitro diagnostic device
	Symbol for waste electrical and electronic equipment (WEEE) according to EU Directive 2012/19/EU, European Community
	UL listing certification mark: Declaration of conformity, USA
	Certification mark for electromagnetic compatibility of the <i>Federal Communications Commission</i> , USA
	Certification mark China – Use of certain hazardous substances in electrical and electronic products (<i>Requirements for Concentration Limits for Certain Hazardous Substances in Electronic Information Products SJ/T 11363-2006</i>), People's Republic of China

4 Installation

4.1 Selecting the location



WARNING! Danger due to incorrect voltage supply.

- ▶ Only connect the device to voltage sources which correspond with the electrical requirements specified on the name plate.
 - ▶ Only use earth/grounded sockets with a protective earth conductor.
 - ▶ Only use the mains/power cord supplied.
-



NOTICE! If a fault occurs, any objects in the immediate proximity of the device will be damaged.

- ▶ In accordance with the recommendations of EN 61010-2-020, leave a safety clearance of **30 cm** around the device during operation.
 - ▶ Please remove all materials and objects from this area.
-



NOTICE! Damage from overheating.

- ▶ Do not install the device near heat sources (e.g., heaters, drying cabinets).
 - ▶ Do not expose the device to direct sunlight.
 - ▶ Ensure unobstructed air circulation. Maintain a clearance of at least 30 cm around all ventilation gaps.
-



NOTICE! Radio interference.

For devices with Class A noise emission in accordance with and , the following applies: This device has been developed and tested in accordance with CISPR 11 Class A. The device may cause radio interference in domestic environments and is not intended for use in residential areas. The device cannot ensure adequate protection of radio reception in residential areas and domestic environments.

- ▶ If necessary, take appropriate measure to eliminate the interferences.
-



Mains/power connection for centrifuges: Operation of the centrifuge is only permitted in building installations that comply with the applicable national regulations and standards. In particular, it must be ensured that there are no impermissible loads on the supply lines and assemblies that are located upstream of the internal protection of the device. This can be ensured by using additional circuit breakers or other suitable fuse elements in the building installation.



The mains/power switch and the disconnecting device of the mains/power line must be accessible during operation (e.g., residual current circuit breaker).

Installation

Centrifuge 5702/5702 R/5702 RH
English (EN)

Select the location of the device according to the following criteria:

- Mains/power connection in accordance with the name plate
 - Minimum distance to other devices and walls: 30 cm
 - Resonance free table with horizontal even work surface
 - The surrounding area must be well ventilated.
 - The location is protected against direct sunlight.
- ▶ Do not use this device near strong electromagnetic sources (e.g. unshielded high frequency sources) as they could impede proper functioning of the device.

4.2 Preparing installation



CAUTION! Risk of injury due to lifting and carrying heavy loads.

The device is heavy. Lifting and carrying the device can lead to back injuries.

- ▶ Transport and lift the device with an adequate number of helpers.
- ▶ Use a transport aid to transport the device.



The device may only be stored and transported in its original packing.

- ▶ Retain the original packing, transport straps, packing material and transport securing devices.
- ▶ Do not cut up the transport straps.

Unpacking the centrifuge

1. Open the transport packing.
2. **Centrifuge 5702:** Remove the covering cardboard.
3. Take the accessories out of the packing.
4. Use the transport straps to lift the centrifuge out of the packing.
5. Place the device on a suitable work surface.
6. Remove the transport straps from the centrifuge.
7. There is a transport securing device attached to the front and the rear panel of the centrifuge. Remove the transport securing devices.
8. Remove the plastic sleeve.
9. **Centrifuge 5702:** The transport securing device for the motor is located underneath the centrifuge. Lift the centrifuge on one side and remove the transport securing device.
10. **Centrifuge 5702 R, Centrifuge 5702 RH:** Insert the condensation water tray.

4.3 Installing the instrument



WARNING! Danger due to incorrect voltage supply.

- ▶ Only connect the device to voltage sources which correspond with the electrical requirements specified on the name plate.
- ▶ Only use earth/grounded sockets with a protective earth conductor.
- ▶ Only use the mains/power cord supplied.



NOTICE! Damage to electronic components due to condensation.

Condensate may form in the device when it has been transported from a cool environment to a warmer environment.

- ▶ After installing the device, wait for at least 3 h. Only then connect the device to the mains/power line.



NOTICE! Centrifuge 5702 R, Centrifuge 5702 RH: Compressor damage after improper transport.

- ▶ After installation, wait 4 hours before switching on the centrifuge.
-

Prerequisites

- The device has been prepared in accordance with the operating manual.
 - The device has adapted to the ambient temperature (waiting time 3 h).
 - The compressor is ready for operation (waiting time 4 h).
1. Connect the mains/power cord of the centrifuge to the mains/power supply.
 2. Switch on the centrifuge using the mains/power switch.
 - The **standby** key lights up green.
 - The display is active.
 3. Open the centrifuge lid using the **open** key.

Installation

Centrifuge 5702/5702 R/5702 RH

English (EN)

5 Operation

5.1 Operating controls

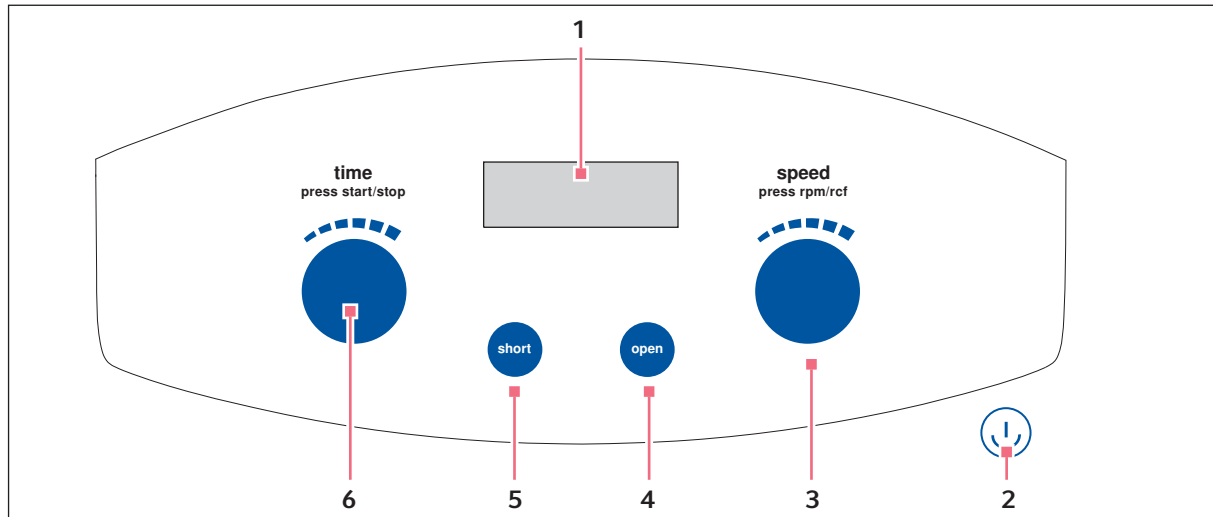



Fig. 5-1: Centrifuge 5702 operating controls

- | | |
|---|---|
| <p>1 Display</p> <p>2 Standby  key
Activate/deactivate standby mode
Key lights up green: Centrifuge is operational
Key lights up red: Standby mode is active</p> <p>3 Rotary knob speed
Turn the knob: Set the centrifugation speed.
Press the knob briefly: Switch the display of the centrifugation speed (to rpm or rcf)</p> | <p>4 open key
Release the lid.</p> <p>5 short key
Short run centrifugation</p> <p>6 Rotary knob time
Turn the knob: Set the centrifugation time.
Press the knob: Start or stop the centrifugation.</p> |
|---|---|

Operation

Centrifuge 5702/5702 R/5702 RH
English (EN)

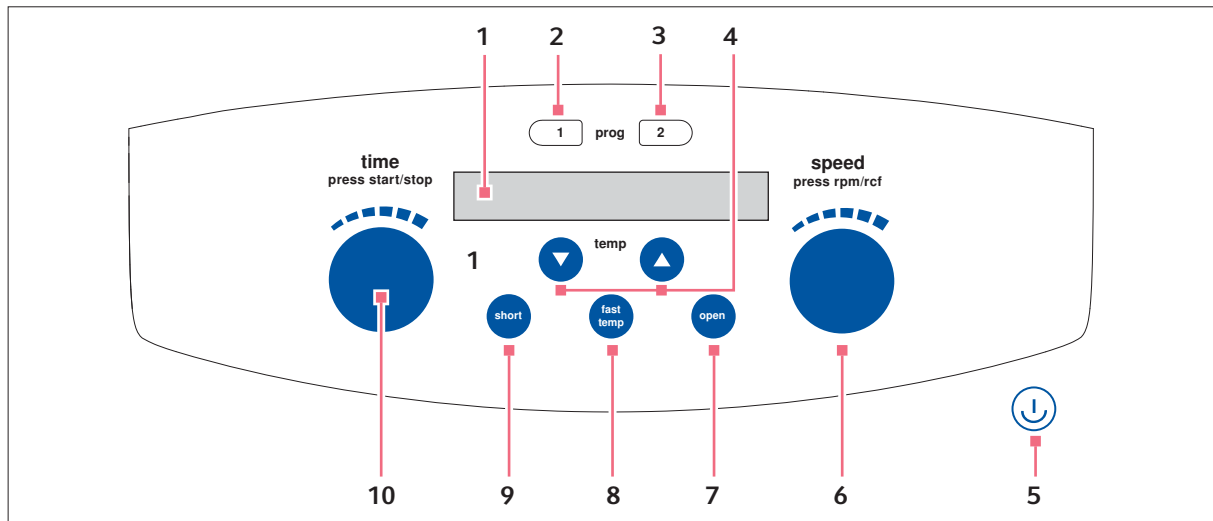



Fig. 5-2: Centrifuge 5702 R/Centrifuge 5702 RH operating controls

- | | |
|---|---|
| <p>1 Display</p> | <p>6 Rotary knob speed
Turn the knob: Set the centrifugation speed.
Press the knob: Switch the display of the centrifugation speed (to rpm or rcf)</p> |
| <p>2 prog 1 key
Press the key briefly: Load program 1.
Press the key for > 2 s: Save current parameters.</p> | <p>7 open key
Release the lid.</p> |
| <p>3 prog 2 key
Press the key briefly: Load program 2.
Press the key for > 2 s: Save current parameters.</p> | <p>8 fast temp key
Start the FastTemp temperature control run.</p> |
| <p>4 temp arrow keys
Set the temperature.
Press and hold the arrow key: Quick setting</p> | <p>9 short key
Short run centrifugation</p> |
| <p>5 Standby  key
Activate/deactivate standby mode
Key lights up green: Centrifuge is operational
Key lights up red: Standby mode is active</p> | <p>10 Rotary knob time
Turn the knob: Set the centrifugation time.
Press the knob: Start and stop centrifugation.</p> |

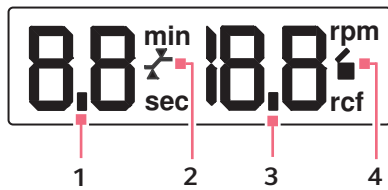

Fig. 5-3: Centrifuge 5702 display

- | | |
|--|---|
| <p>1 Centrifugation time [min, s]
Actual value</p> <p>2 At set rpm function
 : Time counting begins at 95% of the set g-force [rcf] or speed [rpm].
 : Time counting begins immediately.</p> | <p>3 Rotational speed [rpm] or g-force [rcf]
Actual value</p> <p>4 Centrifuge status
 : The centrifuge lid is unlocked.
 : The centrifuge lid is locked.
 (Flashes): Centrifugation in progress.</p> |
|--|---|

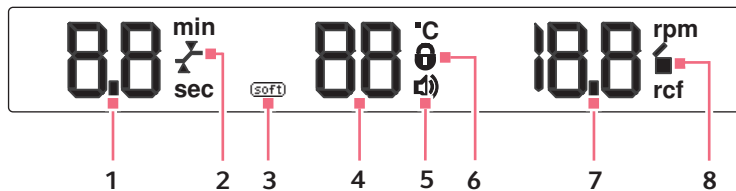

Fig. 5-4: Centrifuge 5702 R/Centrifuge 5702 RH display

- | | |
|---|---|
| <p>1 Centrifugation time [min, s]
Actual value</p> <p>2 At set rpm function
 : Time counting begins at 95% of the set g-force [rcf] or speed [rpm].
 : Time counting begins immediately.</p> <p>3 Soft ramp
 : Rotor accelerates and brakes slowly.
 No symbol: Rotor accelerates and brakes rapidly.</p> <p>4 Temperature in the rotor chamber [°C]
Actual value</p> | <p>5 Key lock
 : Key lock is activated Parameters cannot be changed.
 : Key lock is not activated</p> <p>6 Speaker
 : The speaker is switched on.</p> <p>7 Rotational speed [rpm] or g-force [rcf]
Actual value</p> <p>8 Centrifuge status
 : The centrifuge lid is unlocked.
 : The centrifuge lid is locked.
 (Flashes): Centrifugation in progress.</p> |
|---|---|



Only Centrifuge 5702 R: When setting the soft ramp, the symbol only appears on the display as of serial number 03556 and higher.
For devices with serial numbers < 03556 (see *Setting the soft ramp* on p. 39).

5.2 Switching on the centrifuge

Prerequisites

- The device has been installed in accordance with the operating manual.

1. Switch the centrifuge on using the mains/power switch.
2. Press the **Standby** key, if required.
The display shows the parameters of the last run.
3. Press the **open** key to open the closed centrifuge lid.

5.3 Replacing the rotor



NOTICE! If handled incorrectly, the rotor may fall.

The swing-bucket rotor may fall if the buckets are used as handles.

- ▶ Remove the buckets before inserting and/or removing a swing-bucket rotor.
- ▶ Always use both hands to carry the rotor cross.



NOTICE! Material damage due to improper rotor insertion.

The motor shaft or bearing may become damaged if the rotor falls into the motor shaft guides in an uncontrolled manner when it is inserted.

- ▶ Hold the rotor with both hands.
- ▶ Guide the rotor onto the motor shaft.

5.3.1 Inserting the rotor

1. Align the peg of the motor shaft.
2. Place the rotor vertically onto the motor shaft from the top.
The arrows on the rotor show the position of the groove. The pegs of the motor shaft must fit into the groove of the rotor.
If required, lift the rotor and replace it onto the motor shaft.
3. Insert the rotor key supplied into the rotor nut.
4. Turn the rotor key **clockwise** until the rotor nut is firmly tightened.

5.3.2 Removing the rotor

1. Turn the rotor nut **counterclockwise** using the rotor key supplied.
2. Remove rotor by lifting it vertically.

5.4 Loading a fixed-angle rotor



CAUTION! Risk of injury due to asymmetric loading of a rotor.

- ▶ Load rotors symmetrically with identical tubes.
- ▶ Only load adapters with suitable tubes.
- ▶ Always use the same type of tubes (weight, material/density and volume).
- ▶ Use a balance to check that the load is symmetrical by balancing the adapters and tubes that are used.

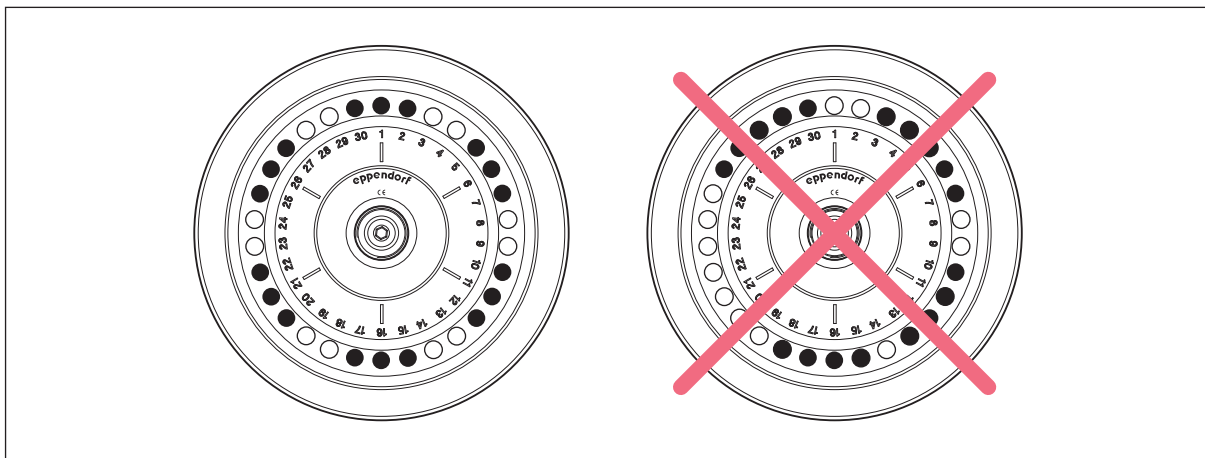

Fig. 5-5: Symmetrical loading of a fixed-angle rotor

1. Check maximum load (adapter, vessel, and contents) for each rotor bore.
2. Load rotors and adapters only with the tubes intended for them.
3. To ensure symmetrical loading, insert sets of two tubes in opposite bores.

Tubes located opposite each other must be of the same type and contain the same filling quantity.

To minimize weight differences between filled sample tubes, we recommend taring with a balance. This will reduce wear of the drive and operating noise.

5.5 Loading a swing-bucket rotor



CAUTION! Risk of injury due to asymmetric loading of a rotor.

- ▶ Always load all positions of a swing-bucket rotor with buckets.
- ▶ Load buckets symmetrically with identical tubes or plates.
- ▶ Only load adapters with suitable tubes or plates.
- ▶ Always use tubes or plates of the same type (weight, material/density and volume).
- ▶ Use a balance to check that loading is symmetrical by balancing the adapters and tubes or plates that are used.

5.5.1 Inserting the bucket in the swing-bucket rotor

Prerequisites

- The combination of rotor, bucket, adapter and tube has been approved by Eppendorf.
 - Buckets that are located opposite each other belong to the same weight class. The weight class is engraved in the sides of the groove: e.g., 68.
 - The grooves of the buckets are clean and slightly coated with pivot grease.
1. Check the maximum load (adapter, tube, and contents) for each bucket. Check the length of the tubes.
On each rotor there is an indication of the weight that a fully loaded bucket must not exceed.
 2. Insert the bucket into the rotor. Load the rotor symmetrically.
All rotor positions must be equipped with buckets.
Only place buckets with the same weight class in opposite locations.
 3. Check to see if all buckets are completely hung and can freely swing out.



- ▶ If you use tubes or plates for the first time, perform a swing-out test.

5.5.2 Performing an imbalance calibration

To check whether the buckets can swing out, you can perform a manual swing-out test. The maximum speed of centrifugation is 1000 rpm.

Perform the swing-out test under the following conditions:

- The tubes are used for the first time.
 - Tubes with a length of > 100 mm are used.
1. Equip the buckets with tubes.
 2. Equip the rotor with buckets.
 3. Accelerate the rotor until the buckets swing out up to 90°.

The swing-out test was successful with the following results:

- The buckets swing out freely.
- The tubes do not touch the rotor cross.

5.5.3 Loading buckets symmetrically



NOTICE! Material damage due to incorrect equipping of the swing-bucket rotor.

Incomplete equipping of the swing-bucket rotor or an uneven load will reduce the life span of the rotor and the corresponding buckets considerably.

- ▶ Always load all positions of a swing-bucket rotor with buckets.
- ▶ Load opposite buckets with the same weight (adapter, tubes, or plates and content).

5.5.3.1 Equipping buckets with tubes

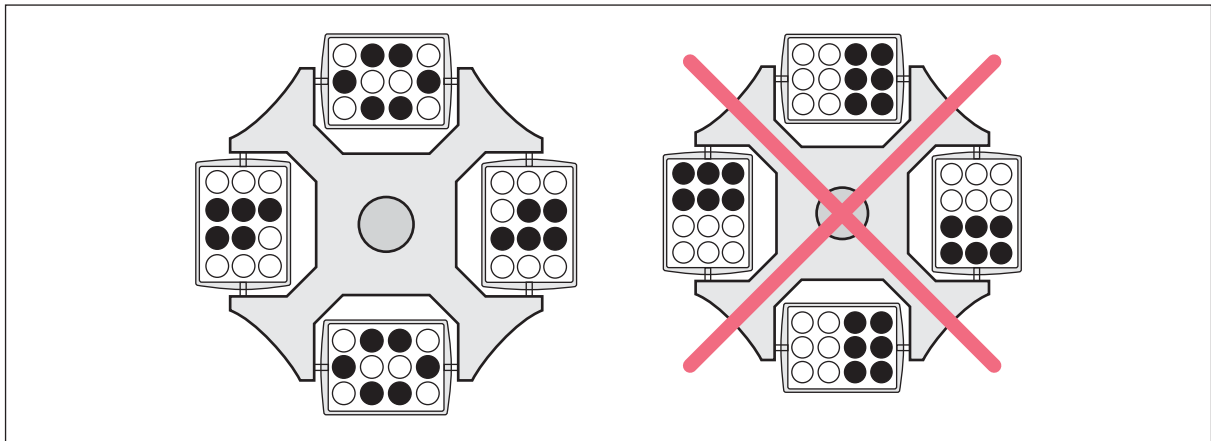

Fig. 5-6: Correct and incorrect loading of the buckets

The loading shown on the right-hand side is incorrect as it places an uneven load on the pegs of the rotor.

- ▶ To reduce vibrations and noise, load all buckets of the swing-buckets rotor equally.

Operation

Centrifuge 5702/5702 R/5702 RH
English (EN)

5.5.3.2 Closing the round bucket with the cap**CAUTION! Risk of injury due to chemically damaged rotor lids or caps.**

Transparent rotor lids or caps made from PC, PP or PEI may lose their strength under the impact of organic solvents (e.g. phenol, chloroform).

- ▶ If rotor lids or caps have come into contact with any organic solvents, they should be cleaned immediately.
- ▶ Regularly check the rotor lids and caps for damage and cracks.
- ▶ Replace any rotor lids or caps showing any cracks or milky discolorations immediately.

**NOTICE! Damage to the cap due to organic solvents.**

The cap is made from polycarbonate. Polycarbonate is not resistant to phenol and chloroform.

Phenol and chloroform vapors damage the cap and reduce the aerosol tightness.

- ▶ If you are using the cap, do not centrifuge any substances which contain phenol or chloroform.

You can close the round bucket using an aerosol-tight cap.

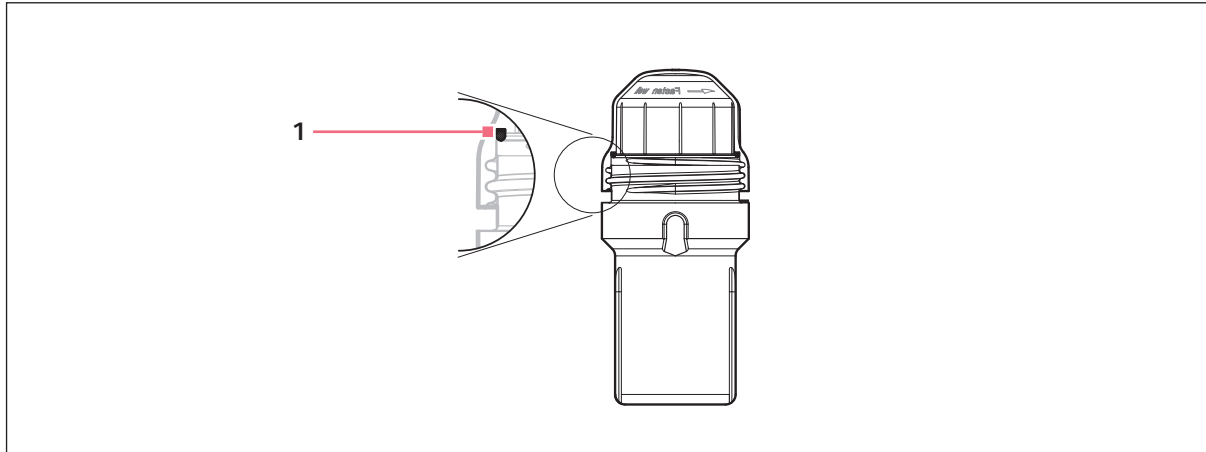

Fig. 5-7: Round bucket with cap

1 Sealing ring

1. Check the sealing ring in the cap.
The sealing ring is not damaged and sits evenly in the groove.
2. Place the cap on the bucket and tighten it.

5.6 Closing the centrifuge lid



WARNING! Risk of injury when opening or closing the centrifuge lid.

There is a risk of crushing your fingers when opening or closing the centrifuge lid.

- ▶ Do not reach between the device and centrifuge lid when opening or closing the centrifuge lid.
- ▶ Do not reach into the locking mechanism of the centrifuge lid.
- ▶ Open the centrifuge lid fully to ensure that the centrifuge lid cannot slam shut.

1. Check that the rotor is attached correctly.
2. Press the centrifuge lid down until it is gripped by the lid latch. The lid will be closed automatically.
 - The  symbol appears on the display.

5.7 Using the timer function



The timer function is a new feature that was developed for Centrifuges 5702 / R / RH. If your centrifuge is not equipped with this feature ex factory, it can be installed by means of a software update. Contact your local Eppendorf partner for this. The contact address can be found on the Internet at <https://www.eppendorf.com>.

A timer can be activated to start a centrifugation run at a later time.

The timer has to be reactivated for each centrifugation run.

The device uses the timer interval from the previous centrifugation run.

The countdown only appears on the display after the timer has started.

5.7.1 Accessing the timer menu

Prerequisites

- All parameters for the subsequent centrifugation run have been set.
- The centrifuge lid is open.

1. Briefly press the **time** rotary knob.
 - The timer menu opens.
 - The time entered and **cd** are displayed.

5.7.2 Setting and activating the timer

Prerequisites

The timer menu has been opened.

1. To enter a time between 10 s and 99 min, turn the **time** rotary knob.
2. To save the value, briefly press the **time** rotary knob.
 - The timer is activated.
 - The timer menu closes.
 - The parameters previously set for the centrifugation run are displayed.
3. Close the centrifuge lid.
4. To start the centrifugation run using the timer, briefly press the **time** rotary knob.

The centrifuge starts the centrifugation run when the countdown reaches zero.
When the centrifugation run is completed, only the previously set time is saved.
The timer is deactivated for the next centrifugation run.



Closing the centrifuge lid before the timer interval has been saved or pressing the **open** key cancels the activation.

5.7.3 Deleting the timer interval

Prerequisites

- The centrifuge lid is open.
 - The timer menu is open.
 - Entering a timer interval is possible.
1. Turn the **time** rotary knob to the left until -- is displayed.
 2. To confirm the input, press the **time** rotary knob.

The timer menu is closed without activating the timer.

5.7.4 Deactivating the activated timer

Prerequisites

- The centrifugation run with timer has started.
 - The countdown is running.
1. Briefly press the **time** rotary knob.
 - The centrifugation run starts immediately.
 - The timer is deactivated.

5.7.5 Canceling the activated timer

Prerequisites

- The centrifugation run with timer has started.
- The countdown is running.

1. Open the centrifuge lid by pressing the **open** key.
 - The timer is canceled and has to be reactivated via the timer menu for the next centrifugation run.

5.8 Centrifugation



WARNING! Risk of injury from improperly attached rotors and rotor lids.

- ▶ Only centrifuge with the rotor and rotor lid firmly tightened.
 - ▶ If any unusual noises occur when the centrifuge starts, the rotor or the rotor lid may not be attached properly. Stop the centrifugation immediately.
-

Prerequisites:

- The centrifuge is switched on.
- The rotor has been inserted and attached correctly.
- The rotor has been loaded correctly.
- The buckets can swing out freely.

5.8.1 Centrifugation with time setting

5.8.1.1 Setting the centrifugation parameters

Prerequisites

The centrifuge lid is closed.

Setting the centrifugation parameters

1. Use the **time** rotary knob to set the centrifugation time.
2. Centrifuge 5702 R, Centrifuge 5702 RH: Use the **temp** arrow keys to set the temperature.
3. Use the **speed** rotary knob to set the speed of centrifugation.

Starting the centrifugation run

4. To start the centrifugation run, press the **time** rotary knob.

Display during centrifugation

- ■ flashes on the display while the rotor is running.
- Remaining run time in minutes. The last minute is counted in seconds.
- Centrifuge 5702 R, Centrifuge 5702 RH: actual temperature in the rotor chamber
- Current *g-force* (rcf) or rotational speed (rpm)

Operation

Centrifuge 5702/5702 R/5702 RH
English (EN)

Changing parameters during the run

- To change the following centrifugation parameters during the run, briefly press the **short** key.
The display flashes.



During the run you can change the following parameters:

- Centrifugation time
The shortest new run time that can be set must be 2 min above the elapsed time.
- Centrifuge 5702 R, Centrifuge 5702 RH: Temperature
- Centrifugation speed
During the run, you can switch between the *g*-force and the rotational speed display using the **speed** key.
The changed centrifugation parameters are adopted after 3 s.

5.8.1.2 End of centrifugation

- ▶ To abort the centrifugation, press the **time** rotary knob.
 - The centrifuge stops automatically when the set time has elapsed.
 - During the braking process, the elapsed run time flashes on the display.
 - The signal sounds when the rotor is stopped.
 - To maintain the temperature in the rotor chamber, the centrifuge lid of Centrifuge 5702 R and Centrifuge 5702 RH remains closed. Press the **open** key to open the lid.
 - The centrifuge lid of Centrifuge 5702 opens automatically.

5.8.2 Centrifuging in continuous operation

Prerequisites

The centrifuge lid is closed.

Setting up the continuous run

- In order to centrifuge without any time limits, select the ∞ setting using the **time** rotary knob (before 0.5 min and after 99 min).
The ∞ icon appears on the display.
- Centrifuge 5702 R, Centrifuge 5702 RH: Use the **temp** arrow keys to set the temperature.
- Use the **speed** rotary knob to set the speed of centrifugation.

Starting the continuous run

- To start the centrifugation run, press the **time** rotary knob.

Stopping the continuous run

- To stop the centrifugation run, press the **time** rotary knob.
 - During the braking process, the centrifugation time flashes on the display.
 - The signal sounds when the rotor is stopped.
- To maintain the temperature in the rotor chamber, the centrifuge lid of Centrifuge 5702 R and Centrifuge 5702 RH remains closed. Press the **open** key to open the lid.
The centrifuge lid of Centrifuge 5702 opens automatically.

5.8.3 Short run centrifugation

Prerequisites

The centrifuge lid is closed.

Short run centrifugation runs as long as the **short** key is pressed. The centrifugation is performed at the maximum rotational speed of the rotor.

1. Centrifuge 5702 R, Centrifuge 5702 RH: Use the **temp** arrow keys to set the temperature.
2. To start the short run centrifugation, press and hold the **short** key.
3. Release the **short** key to end short run centrifugation.
During the braking process, the centrifugation time flashes on the display.
4. To maintain the temperature in the rotor chamber, the centrifuge lid of Centrifuge 5702 R and Centrifuge 5702 RH remains closed. Press the **open** key to open the lid.
The centrifuge lid of Centrifuge 5702 opens automatically.

5.8.4 Setting the soft ramp

For the Centrifuge 5702/5702 R/5702 RH, 2 settings for soft ramps are available. Use the soft ramps for sensitive applications.

Prerequisites

- The centrifuge lid is open.

1. To check which soft ramps are set, briefly press the **short** key.
The display shows the set soft ramps.

Soft ramps	Centrifuge 5702	Centrifuge 5702 R serial number < 03556	Centrifuge 5702 R serial number > 03556	Centrifuge 5702 RH
Fast	<i>br on</i>	<i>br on</i>	No symbol	No symbol
Slow	<i>br OF</i>	<i>br OF</i>	soft	soft

2. Press the **short** key for > 5 s.
The soft ramp setting is changed. The display shows the current status.
3. To change the soft ramp setting again, press the **short** key for > 5 s.

Operation



Centrifuge 5702/5702 R/5702 RH
English (EN)

5.8.5 Setting the start of the time counting (At set rpm function)

Prerequisites

- The centrifuge lid is open.

You can specify when time counting starts.

Start of time counting	Display
time counting begins immediately (setting on delivery)	
Time counting starts when 95% of the <i>g-force</i> or rotational speed has been reached.	

1. Press the **time** key for > 2 s.

The start of the time counting is changed. The display shows the current status.

2. To change the start of the time counting again, press the **time** rotary knob for > 2 s.

5.8.6 Calculating the speed of centrifugation

The *g-force* that is shown on the display is standardized to the A-4-38 rotor with conical tubes 15 mL without adapter. If you use other rotors and adapters, other *g-forces* are reached.



The maximum *g-force* and maximum radius for the respective rotors and adapters can be found in chapter "Rotors, tubes, adapters"(see *Rotors, tubes and adapters on p. 73*).

To calculate the *g-force*, use the following formula in accordance with DIN 58970:

- $rcf = 1.118 \cdot 10^{-5} \cdot n^2 \cdot r_{\max}$
 - rcf: *g-force*
 - n: rotational speed in rpm
 - r_{\max} : maximum centrifugation radius in cm

Example 1

- The adapter for HPLC vials in the F-45-18-17-Cryo rotor has a maximum radius of 8.3 cm.
- At 6142 rpm, a max. *g-force* of $3\,500 \times g$ is reached.

Example 2

- The 100 mL adapter has a maximum radius of 13.5 cm.
- At 4,000 rpm, a maximum *g-force* of $2,415 \times g$ is reached.

5.9 Centrifuge 5702 R, Centrifuge 5702 RH: Heating and cooling

With Centrifuge 5702 R, the rotor chamber can be cooled. With Centrifuge 5702 RH, the rotor chamber can be heated and cooled.



The temperature that can actually be reached depends on the rotor and the set rotational speed.

In case of a rotor stop (continuous cooling), cooling takes longer than during centrifugation or a temperature control run.



At higher ambient temperatures, a brief fan noise is possible until the set temperature has been reached. Fan noise indicates a heavy cooling performance.

At ambient temperatures of $< 18^{\circ}\text{C}$, a running-in period of approx. 1 h is required for proper operation.

5.9.1 Setting the temperature

Prerequisites

- The centrifuge is switched on.

1. Use the **temp** arrow keys to set the target temperature.
2. Set the centrifugation time and speed of centrifugation.
3. To start the centrifugation, press the **time** rotary knob.

The temperature can be changed during centrifugation.

5.9.2 Temperature display

Temperature during rotor stop:

The display alternately shows the set temperature (long) and the actual temperature (short)

Temperature display during centrifugation:

actual temperature

5.9.3 Temperature monitoring

After the set temperature has been reached, the centrifuge reacts to temperature deviations during centrifugation as follows:

Deviation from the set temperature $> \pm 3^{\circ}\text{C}$

Temperature display flashes

Deviation from the set temperature $> \pm 5^{\circ}\text{C}$

Display shows *Er 18*. Centrifugation is stopped automatically.

The temperature can be changed during centrifugation.

5.9.4 Temperature control run FastTemp

Reasons for a temperature control run

- Rotor chamber, rotor and adapter should reach the desired temperature quickly.
- To perform an exactly tempered run, start a short temperature control run immediately before centrifugation. This prevents the temperature in the rotor bowl from overshooting, e.g. after longer downtimes.
- If the centrifuge has been in continuous cooling mode for a long time or at low temperatures, start a short temperature control run before inserting the samples. The temperature control run prevents the samples from freezing.

5.9.4.1 Start FastTemp temperature control run

With the FastTemp function, you can immediately start a temperature run without samples, at rotor-specific or temperature-specific speeds. This will quickly bring the rotor chamber, including rotor and adapter, up to the set temperature.

Prerequisites

- The centrifuge is switched on.
- Rotor, rotor lid and adapter are correctly mounted.
- The centrifuge lid is closed.

1. Set the speed of centrifugation for the following run.
2. Use the arrow keys to set the target temperature.
3. Press the **fast temp** key.

The display shows the following information:

- *FA*
- Actual temperature in the rotor chamber
- Rotational speed

When the set temperature has been reached, the FastTemp temperature control run stops automatically. If the speaker is activated, a periodic alarm sounds.

4. To end the FastTemp temperature control run early, press the **time** rotary knob.



- The centrifuge only stops the FastTemp temperature control run when the rotor is completely tempered. Therefore, there may be a delay between the display of the achieved target temperature and the automatic end of the temperature control run.
- During the temperature control run, the target temperature can be changed using the **temp** arrow keys. Duration and speed of the temperature control run are adapted automatically.

5.9.4.2 Temperature control run with aerosol-tight caps

If you perform a temperature control run and close the buckets with aerosol-tight caps, negative pressure builds up in the buckets. After the temperature control run, the caps cannot be removed.

1. Do not use aerosol-tight caps for a temperate control run.
2. Temper buckets and adapters without aerosol-tight caps.

5.9.5 Continuous cooling

The continuous cooling keeps the set temperature in the rotor chamber during rotor stop.

- During continuous cooling, the set temperature is displayed.
- Irrespective of the set temperature, the temperature does not go below 4 °C to prevent the rotor chamber from freezing and to prevent condensation.
- In case of a rotor stop, temperature control takes longer than during centrifugation or a temperature control run.
- Continuous cooling stops after 8 h.

Prerequisites

- The centrifuge is switched on.
- The centrifuge lid is closed.
- The set temperature is lower than the ambient temperature.

1. Continuous cooling starts automatically.

5.9.6 Centrifuge 5702 RH: Temperature profiles

The Centrifuge 5702 RH has a controlled heating and refrigeration system. This makes it possible to exactly temper sensitive samples.

A special temperature profile is stored in the software for each rotor. The temperature profile defines the speed at which the rotor performs the FastTemp temperature control run. The aim is to temper the rotor chamber and the rotor to the set temperature in the shortest possible time. The temperature is to be maintained, with small tolerances.

Prerequisites

- The centrifuge lid is open.

1. Press the **fast temp** key.

The last selected temperature profile is displayed.

Display	Rotor
<i>ro F 35</i>	Rotor F-35-30-17
<i>ro F 24</i>	Rotor F-45-24-11
<i>ro F 18</i>	Rotor F-45-18-17-Cryo
<i>ro A4 rE</i>	Rotor A-4-38 with rectangular buckets
<i>ro A4 ro</i>	Rotor A-4-38 with round buckets
<i>ro A8</i>	Rotor A-8-17
<i>ro AL L</i>	Temperature profile for all rotors

2. Use the arrow keys to select the temperature profile for the rotor used.

The selected temperature profile is adopted after 3 s. The display shows the default values again.

5.10 Information on aerosol-tight centrifugation



WARNING! Damage to health due to limited aerosol tightness if an incorrect rotor/rotor lid combination is used.

Aerosol-tight centrifugation is only guaranteed if the rotors and rotor lids intended for this purpose are used. The designation of aerosol-tight fixed-angle rotors always starts with **FA**. The aerosol-tight rotors and rotor lids of this centrifuge are also marked with a red ring on the rotor and a red rotor lid screw.

- ▶ Always use rotors and rotor lids marked as aerosol-tight together for aerosol-tight centrifugation. The details specifying in which centrifuge the aerosol-tight rotors and rotor lids may be used can be found on the rotor and on the top of the rotor lid.
- ▶ Only use aerosol-tight rotor lids in combination with the rotors indicated on the rotor lid.
- ▶ Only use aerosol-tight buckets with the corresponding caps.



WARNING! Damage to health due to limited aerosol tightness if used incorrectly.

Mechanical stresses and contamination by chemicals or other aggressive solvents may impair the aerosol tightness of the rotors and rotor lids. Autoclaving at excessively high temperatures can lead to plastic tubes, adapters and rotor lids becoming brittle and deformed.

- ▶ Check the integrity of the seals of the aerosol-tight rotor lids or caps before each use.
- ▶ Only use aerosol-tight rotor lids or caps if the seals are undamaged and clean.
- ▶ Do not exceed temperatures of 121 °C or a time of more than 20 min. when autoclaving.
- ▶ After each proper autoclaving process (121 °C, 20 min.), coat the threads of the rotor lid screw with a thin layer of pivot grease (order no. Int. 5810 350.050, North America 022634330).
- ▶ Replace aerosol-tight rotor lids without replaceable seals after 50 autoclaving cycles.
- ▶ On aerosol-tight rotor lids with exchangeable seals (e.g. QuickLock rotor lids) the seal only needs to be replaced after 50 autoclaving cycles.
- ▶ Replace aerosol-tight rotor caps after 50 autoclaving cycles.
- ▶ **Never** close aerosol-tight rotors or buckets for storage.



The aerosol tightness of rotors, rotor lids, buckets and caps has been tested and certified according to Annex AA of IEC 61010-2-020.

5.10.1 Aerosol-tight centrifugation in a fixed-angle rotor

To ensure aerosol tightness, the following applies:

- Replace aerosol-tight rotor lids without exchangeable seal and cap after 50 autoclaving cycles.
- Replace the seal of aerosol-tight rotor lids with exchangeable seal (e.g., QuickLock rotor lids) after 50 autoclaving cycles.
- Lightly grease the replaced seal with pivot grease after it is inserted.

5.11 Switching off the centrifuge

1. Open the centrifuge lid.
Residual moisture can evaporate.
2. Remove the aerosol-tight caps from the buckets.
3. Remove rotor lids from fixed-angle rotors.
Aerosol-tight accessories may not be stored with the lid closed.
4. Switch off the centrifuge using the mains/power switch.

Operation



Centrifuge 5702/5702 R/5702 RH
English (EN)

6 Device settings



6.1 Changing the operating state

The centrifuge has 2 operating states, the ready state and standby mode. You can actively change between the two operating states.

The **Standby**  key shows the operating state of the device.





- The device is ready for operation: The **Standby**  key lights up green.
- The device is in standby mode: The **Standby**  key lights up red.

Prerequisites

- The centrifuge is not performing a run.
- ▶ Press the **Standby**  key to change the operating state.
The operating state changes. The **Standby**  key changes color.

6.2 Key lock

The display shows whether the key lock is activated.

	Centrifuge 5702	Centrifuge 5702 R	Centrifuge 5702 RH
Key lock is activated	<i>Lo on</i>		
Key lock is deactivated	<i>Lo OF</i>		

If the key lock is activated, the following centrifugation parameters cannot be changed:

- Centrifugation time
- Centrifuge 5702 R, Centrifuge 5702 RH: Temperature
- *g-force* or rotational speed
- Soft ramps
- Status of the At set rpm function

The following settings can be changed despite the key lock being activated:

- Start and stop centrifugation. Press the **time** rotary knob.
- Set the unit for the speed of centrifugation [rpm/ rcf]. Press the **speed** rotary knob.

Device settings

Centrifuge 5702/5702 R/5702 RH
English (EN)

Activating the key lock

Prerequisites

- The centrifuge lid is open.
- ▶ Press the **short** and **open** keys simultaneously for > 5 s.
The centrifugation parameters cannot be changed.

Deactivating the key lock

Prerequisites

- The centrifuge lid is open.
- ▶ Press the **short** and **open** keys simultaneously for > 5 s.
The centrifugation parameters cannot be changed.

6.2.1 Centrifuge 5702 R, Centrifuge 5702 RH: Securing the program against changes

1. Use the **prog 1** or **prog 2** key to select the program.
2. Activate the key lock. Press the **short** and **open** keys simultaneously for > 5 s.
The program cannot be changed.

6.2.2 Centrifuge 5702: Displaying the key lock status

On the Centrifuge 5702 R and the Centrifuge 5702 RH, the key lock status is shown on the display.

Prerequisites

- The centrifuge lid is open.
- ▶ Shortly press the **short** and **open** keys simultaneously.
The display shows the current status of the key lock.

6.3 Speakers

The display shows if the speakers are switched on.

	Centrifuge 5702	Centrifuge 5702 R	Centrifuge 5702 RH
Speakers switched on	<i>b on</i>	🔊	🔊
Speakers switched off	<i>b OF</i>	no symbol	no symbol

Switching on the speakers

Prerequisites

- The centrifuge lid is open.
- ▶ Press the **open** key for > 2 s.
 The speakers are switched on.

Switching off the speakers

Prerequisites

- The centrifuge lid is open.
- ▶ Press the **open** key for > 2 s.

6.3.1 Display the status of the speakers

This function is only available for the Centrifuge 5702. On the Centrifuge 5702 R and the Centrifuge 5702 RH the status of the speakers is shown on the display.

Prerequisites

- The centrifuge lid is open.
- ▶ Press the **open** key briefly.
 The display shows the status of the speakers.

Device settings

Centrifuge 5702/5702 R/5702 RH

English (EN)

7 Programs

You can store 2 programs each on the Centrifuge 5702 R and on the Centrifuge 5702 RH.

You can set the following parameters for each program:

- Centrifugation time
- Temperature
- Centrifugation speed
- Start of time measurement (function At set rpm)
- Settings for the soft ramp

7.1 Creating and storing a program

You can store two programs on the device

Prerequisites

- Rotor stop.
1. Use the rotary knob **time** to set the centrifugation time.
 2. Use the **temp** arrow keys to set the temperature.
 3. Use the rotary knob **speed** to set the speed of centrifugation.
 4. Set the start of time counting (function At set rpm). Press rotary knob **time** > 2 s to do this.
 5. Press the **short** key > 5 s to set the soft ramp.
 6. Select the program slot. Press the **prog 1** key or the **prog 2** key > 2 s.
 - A signal sounds.
 - The program key does not flash any more. The program key lights up blue.
 - The parameters of the program are saved.

7.2 Saving the current settings as a program

You can save the current settings as a program.

Prerequisites

- Rotor stop.
- ▶ Press the **prog 1** key or the **prog 2** key > 2 s.
- A signal sounds.
 - The program key lights up blue.
 - The parameters of the program are saved.

Programs

Centrifuge 5702/5702 R/5702 RH
English (EN)

7.3 Calling up a program

You can call up stored programs.

Prerequisites

- Rotor stop.
- ▶ Press the **prog 1** key or **prog 2** key to call up a program.
 - The program key lights up blue.
 - The display shows the parameters of the program.

7.4 Editing programs

You can overwrite stored programs.



If a program is loaded, the parameters cannot be changed. The following text appears in the display - *Pr 1* for program 1 or *Pr 2* for program 2.

Prerequisites

- The program has been created and stored.
 - The program has been called up. The program key **prog 1** or **prog 2** lights up blue.
1. Press the key again on which the program has been stored.
 - The program key does not light up any more.
 - The display shows the centrifugation parameters.
 - The centrifugation parameters can be adjusted.
 2. Change the centrifugation parameters.
 3. Store the program on the old program slot. Press the **prog 1** key or **prog 2** > 2 s to do this.
 - A signal sounds.
 - The program key does not flash any more. The program key lights up in blue.
 - The parameters of the program are saved.

7.5 Deleting programs

Programs 1 and 2 cannot be deleted. The programs can be overwritten.

7.6 Exiting the program

Prerequisites

- The program has been called up. The program key **prog 1** or **prog 2** lights up blue.
1. Press the **prog 1** key or the **prog 2** key to exit the program.
 - The program key does not light up any more.
 - The display shows the centrifugation parameters.
 - The centrifugation parameters can be adjusted.

8 Maintenance

8.1 Service options

Eppendorf recommends having your device checked and maintained by trained specialist personnel at regular intervals.

Eppendorf offers you tailor-made service solutions for the preventive maintenance, qualification and calibration of your device. For information, offers and contact options, please visit www.eppendorf.com/epservices.

8.2 Service



WARNING! Risk of fire or electrical shock

- ▶ Have the centrifuge's electrical safety, especially the continuity of the protective connections, checked every 12 months by trained and skilled personnel.

We recommend to have the centrifuge and the associated rotors checked by Technical Service during a service at least every 12 months. Please note the country-specific regulations.

8.3 Preparing cleaning/disinfection

- ▶ Clean all accessible surfaces of the device and the accessories at least weekly and when contaminated.
- ▶ Clean the rotor regularly. This way the rotor is protected and the durability is prolonged.
- ▶ Furthermore, observe the notes on decontamination (see *Decontamination before shipment on p. 57*) when the device is sent to the authorized Technical Service for repairs.

The procedure described in the following chapter applies to the cleaning as well as to the disinfection or decontamination. The table below describes the steps required on top of this:

Cleaning	Disinfecting/decontamination
<ol style="list-style-type: none"> 1. Use a mild cleaning fluid to clean the accessible surfaces of the device and the accessories. 2. Carry out the cleaning as described in the following chapter. 	<ol style="list-style-type: none"> 1. Choose the disinfection method which corresponds to the legal regulations and guidelines in place for your range of application. For example, use alcohol (ethanol, isopropanol) or alcohol-based disinfectants. 2. Carry out the disinfection or decontamination as described in the following chapter. 3. Then clean the device and the accessories.



If you have any further questions regarding the cleaning and disinfection or decontamination or regarding the cleaning fluid to be used, contact the Eppendorf SE Application Support. The contact details are provided on the back of this manual.

8.4 Cleaning/disinfection



DANGER! Electric shock due to the ingress of liquid.

- ▶ Switch off the device and disconnect it from the mains/power line before commencing any cleaning or disinfection procedures.
 - ▶ Do not allow any liquids to enter the inside of the housing.
 - ▶ Do not spray clean or spray disinfect the housing.
 - ▶ Only reconnect the device to the mains/power line when it is completely dry, both inside and outside.
-



NOTICE! Damage due to aggressive chemicals.

- ▶ Do not use any aggressive chemicals on the device or its accessories, such as strong and weak bases, strong acids, acetone, formaldehyde, halogenated hydrocarbons or phenol.
 - ▶ If the device has been contaminated by aggressive chemicals, clean it immediately using a mild cleaning agent.
-



NOTICE! Corrosion due to aggressive cleaning agents and disinfectants.

- ▶ Do not use any corrosive cleaning agents, aggressive solvents or abrasive polishes.
 - ▶ Do not incubate the accessories in aggressive cleaning agents or disinfectants for longer periods.
-



NOTICE! Damage from UV and other high-energy radiation.

- ▶ Do not use UV, beta or gamma rays or any other high-energy forms of radiation for disinfection.
 - ▶ Avoid storage in areas with high UV radiation levels.
-



Autoclaving

Fixed-angle rotors and adapters can be autoclaved (121 °C, 20 min).

Rotor crosses of swing-bucket rotors cannot be autoclaved.

After a maximum of 50 autoclaving cycles, the aerosol-tight caps must be exchanged.

8.4.1 Cleaning and disinfecting the device

Cleaning agent:

- alcohol 70% (ethanol, isopropanol)
- mild neutral cleaning agent
- lint-free cloth

1. Open the lid.
2. Switch off the device and disconnect it from the voltage supply.
3. Remove the rotor.
4. Clean and disinfect all accessible surfaces of the device, including the mains/power cord, using a damp cloth and the cleaning agents.
5. Thoroughly clean the rubber seal of the rotor chamber with water.
6. Let the rubber seal dry off.
7. Rub the dry rubber seal with glycerol or talcum. This prevents the rubber seal from becoming brittle. Other components of the device, such as the motor shaft and rotor cone, must not be lubricated.
8. Clean the motor shaft with a soft, dry, lint-free cloth.
9. Check the motor shaft for damage.
10. Check the device for corrosion and damage.
11. Leave the centrifuge lid open when the device is not in use.
12. Only connect the device to the mains/power supply if it is completely dry on the inside and outside.

8.4.2 Cleaning and disinfecting the rotor

1. Inspect the rotor and accessories for damage and corrosion. Do not use damaged rotors or accessories.
2. Clean and disinfect the rotors and accessories with the recommended cleaning agents.
3. Clean and disinfect the rotor bores with a bottle brush.
4. Rinse the rotors and accessories thoroughly with distilled water. Rinse the rotor bores of fixed-angle rotors particularly thoroughly.



Do not immerse the rotor in liquid as liquid can get trapped inside the cavities.

5. Place the rotors and accessories on a towel to dry. Place the fixed-angle rotors with the rotor bores facing down so the bores can dry.
6. Clean the rotor cone with a soft, dry, lint-free cloth. Do not lubricate the rotor cone.
7. Inspect the rotor cone for damage.
8. Place the dry rotor onto the motor shaft.
9. Tighten the rotor nut firmly by turning it **clockwise** with the rotor key.
10. If necessary, equip the fixed-angle rotor with the cleaned adapters.
11. Equip the swing-bucket rotor with the cleaned buckets and adapters.

8.5 Additional care instructions for refrigerated centrifuges

- ▶ Regularly empty and clean the condensation water tray of refrigerated devices. Pull the condensation water tray out to the left from under the device.
- ▶ Regularly defrost the rotor chamber of refrigerated devices to remove any ice. To do so, simply leave the centrifuge lid open or perform a brief temperature control run at approx. 30 °C.
- ▶ Leave the centrifuge lid open when not in use for a long period.
This enables residual moisture to escape. The lid spring is relieved.
- ▶ Wipe up any condensation water in the rotor chamber. Use a soft, absorbent cloth for this.



Leave the centrifuge lid open to allow the condensation water to evaporate.

- ▶ Remove any dust deposits from the ventilation gaps of the centrifuge at least every 6 months using a brush or swab. First switch off the centrifuge and remove the mains/power plug.

8.6 Cleaning glass breakage

When using glass tubes there is a risk of glass breakage in the rotor chamber. The resulting glass splinters are swirled around in the rotor chamber during centrifugation and have a sandblasting effect on the rotor and accessories. The smallest glass particles become lodged in the rubber parts (e.g., the motor guide, the rotor chamber seal, and the rubber mats of adapters).



NOTICE! Glass breakage in the rotor chamber

Glass tubes in the rotor chamber may break if the *g*-force is too high. Broken glass can damage the rotor, accessories and samples.

- ▶ Please note the manufacturer's information on the recommended centrifugation parameters (load and speed).

Effects of glass breakage in the rotor chamber:

- Fine black metal abrasion in the rotor chamber (in metal rotor chambers)
- The surfaces of the rotor chamber and accessories are scratched.
- The chemical resistance of the rotor chamber is reduced.
- Contamination of samples
- Wear on rubber parts

How to proceed in case of glass breakage

1. Remove all splinters and glass powder from the rotor chamber and accessories.
2. Thoroughly clean the rotor and rotor chamber. Thoroughly clean the bores of the fixed-angle rotors, in particular.
3. If required, replace the rubber mats and adapters to prevent any further damage.
4. Regularly check the rotor bores for deposits and damage.

8.7 Replacing the fuses

The holder is located below the mains/power connection.

1. Switch off the device and isolate it from the mains/power supply.
2. Pull the fuse holder out of the device.
3. Replace the fuses.

8.8 Decontamination before shipment

If you are shipping the device to the authorized Technical Service for repairs or to your authorized dealer for disposal please note the following:



WARNING! Risk to health from contaminated device.

1. Observe the information in the decontamination certificate. It is available as a PDF document on our webpage (<https://www.eppendorf.com/decontamination>).
 2. Decontaminate all the parts to be shipped.
 3. Include the fully completed decontamination certificate in the shipment.
-

Maintenance

Centrifuge 5702/5702 R/5702 RH

English (EN)

9 Troubleshooting

If you cannot remedy an error with the recommended measures, please contact your local Eppendorf partner. The contact address can be found on the Internet at www.eppendorf.com.

9.1 General errors

Problem	Cause	Solution
No display.	No mains/power connection.	▶ Check the mains/power connection.
	Mains/power outage.	▶ Check the fuse of the centrifuge. ▶ Check the mains/power fuse of the lab.
Centrifuge lid cannot be opened.	The rotor is still running.	▶ Wait for the rotor to stop.
	Mains/power outage.	1. Check the fuse of the centrifuge. 2. Check the mains/power fuse of the lab. 3. Activate the emergency lid release.
Centrifuge cannot be started.	The centrifuge lid is not closed.	▶ Close the centrifuge lid.
Centrifuge shakes when it starts up.	The rotor is loaded asymmetrically.	1. Stop the centrifuge and load symmetrically. 2. Restart the centrifuge.
Temperature display flashes. (only Centrifuge 5702 R, Centrifuge 5702 RH)	Temperature deviation from set value: ± 3 °C.	▶ Check the settings. ▶ Check unhindered air circulation through the air slots. ▶ Thaw ice or switch off the centrifuge and allow it to cool down.
The standby key lights up red.	• Centrifuge not ready for operation.	▶ Press the Standby key.

9.2 Error messages

If an error message appears, proceed as follows:

- Remedy the fault as described in the "Solution" column.
- Press the **open** key to clear the error message from the display.
- If necessary, repeat centrifugation.

Code	Problem	Cause	Solution
LID		<ul style="list-style-type: none"> • The lid has not been released. 	<ul style="list-style-type: none"> ▶ Close the lid. ▶ Press the rotary knob start/stop. ▶ Open the lid using the emergency release, if required.
LID		<ul style="list-style-type: none"> • Lid has not been locked. 	<ul style="list-style-type: none"> ▶ Close the lid.
Er 2	Device does not start.	<ul style="list-style-type: none"> • Rotor is loaded asymmetrically. 	<ul style="list-style-type: none"> ▶ Load the rotor symmetrically.
Er 3	The centrifuge decelerates without braking.	<ul style="list-style-type: none"> • The tubes touch the centrifuge lid. 	<ul style="list-style-type: none"> ▶ Check the tubes. ▶ Switch off the device. ▶ Switch on the device and wait for approx. 5 min. ▶ Repeat the run.
Er 3-0	After switching on, the display shows Er 3.	<ul style="list-style-type: none"> • The tubes touch the centrifuge lid. 	
Er 3-2	The centrifuge decelerates with braking.	<ul style="list-style-type: none"> • Error in the electronics. 	<ul style="list-style-type: none"> ▶ Switch off the device. ▶ Switch on the device and wait for approx. 5 min. ▶ Repeat the run.
Er 3-3	The centrifuge decelerates without braking.	<ul style="list-style-type: none"> • Error in the electronics. 	
Er 5	The centrifuge decelerates without braking.	<ul style="list-style-type: none"> • Error in the lid latch. 	<ul style="list-style-type: none"> ▶ Close the lid. ▶ Repeat the run.
Er 5-1 – Er 5-3	Run was started. The rotor rotates.	<ul style="list-style-type: none"> • Error in the lid latch. 	
Er 6 – Er 6-6	The centrifuge decelerates without braking.	<ul style="list-style-type: none"> • Error in the electronics. 	<ul style="list-style-type: none"> ▶ Allow device to cool down. ▶ Repeat the run.

Code	Problem	Cause	Solution
Er 7 – Er 7-2	The centrifuge decelerates without braking.	<ul style="list-style-type: none"> • The maximum speed of the rotor is exceeded. • The actual rotational speed of the rotor deviates from the set value. The tolerance is exceeded. 	<ul style="list-style-type: none"> ▶ Check if the mains/power supply voltage corresponds with the technical data.
Er 8	The centrifuge brakes.	<ul style="list-style-type: none"> • Error occurs when the device accelerates or brakes. 	<ul style="list-style-type: none"> ▶ Repeat the run.
Er 9 – Er 9-4	The data of a run is not saved.	<ul style="list-style-type: none"> • Error in the electronics. 	<ul style="list-style-type: none"> ▶ Repeat the run.
Er 10 – Er 10-5	The data of the last run is not saved.	<ul style="list-style-type: none"> • Error in the electronics. 	
Er 11	The centrifuge decelerates without braking.	<ul style="list-style-type: none"> • Mains/power outage during a run. • Error in the electronics. 	<ul style="list-style-type: none"> ▶ Check the mains/power cord. ▶ Repeat the run.
Er 14	The centrifuge can no longer be operated.	<ul style="list-style-type: none"> • Error in the electronics. 	<ul style="list-style-type: none"> ▶ Restart the device.
Er 15/Inb	The centrifuge switches off and decelerates without braking.	<ul style="list-style-type: none"> • Rotor is loaded asymmetrically. 	<ul style="list-style-type: none"> ▶ Load the rotor symmetrically. ▶ Repeat the run.
Er 16 – Er 16-2	The centrifuge switches off and decelerates without braking.	<ul style="list-style-type: none"> • Error in the electronics. 	<ul style="list-style-type: none"> ▶ Check the tubes. ▶ Switch off the device. ▶ Switch on the device and wait for 5 min. ▶ Repeat the run.
Er 17 – Er 17-2	The centrifuge switches off and decelerates without braking.	<ul style="list-style-type: none"> • Error in the electronics. 	<ul style="list-style-type: none"> ▶ Allow device to cool down. ▶ Repeat the run.
Er 18 – Er 18-3	The centrifuge switches off and decelerates without braking. (only Centrifuge 5702 R, Centrifuge 5702 RH)	<ul style="list-style-type: none"> • The temperature in the rotor chamber deviates from the set temperature by more than 5 °C. 	<ul style="list-style-type: none"> ▶ Check the ambient temperature. ▶ Check if the device is exposed to direct sunlight. ▶ Check if there is sufficient clearance around the device.
Er 19 – Er 19-1	The cooling aggregate is switched off. The fan continues to run. (only Centrifuge 5702 R, Centrifuge 5702 RH)	<ul style="list-style-type: none"> • Error in the cooling circuit. 	<ul style="list-style-type: none"> ▶ Check if the air can circulate through the ventilation slots. ▶ Check if there is sufficient clearance around the device.

Troubleshooting

Centrifuge 5702/5702 R/5702 RH
English (EN)

Code	Problem	Cause	Solution
Er 20	The centrifuge switches off and decelerates with braking. The cooling aggregate is switched off. (only Centrifuge 5702 R, Centrifuge 5702 RH)	<ul style="list-style-type: none"> • Error in the electronics 	<ul style="list-style-type: none"> ▶ Repeat the run.
Er 21	The centrifuge switches off and decelerates with braking.	<ul style="list-style-type: none"> • Error in the electronics 	
Er 22	The fan is switched. The error is only displayed if the centrifuge does not perform a run.	<ul style="list-style-type: none"> • Error in the electronics. 	<ul style="list-style-type: none"> ▶ The device can be used.
Er 23	The centrifuge decelerates without braking.	<ul style="list-style-type: none"> • The ambient temperature is too high. • The motor is too hot. 	<ul style="list-style-type: none"> ▶ Check the ambient temperature. ▶ Let the motor cool down. ▶ Repeat the run.
Er 24 – Er 24-3	The centrifuge switches off and decelerates with braking. (only Centrifuge 5702 R, Centrifuge 5702 RH)	<ul style="list-style-type: none"> • Error in the cooling aggregate. 	<ul style="list-style-type: none"> ▶ Allow device to cool down.
Er 25/Int		<ul style="list-style-type: none"> • Mains/power outage during a run. • The mains/power supply voltage fluctuates. • The mains/power supply voltage does not correspond with the technical data. 	<ul style="list-style-type: none"> ▶ Check the mains/power cord. ▶ Wait until the rotor stops rotating. ▶ Repeat the run.
Er 27		<ul style="list-style-type: none"> • Error in the electronics. 	<ul style="list-style-type: none"> ▶ Repeat the run.

9.3 Emergency release

If the centrifuge lid cannot be opened, you can activate the emergency release manually.



WARNING! Risk of injury from rotating rotor.

If the emergency release of the lid is operated, the rotor may continue to rotate for several minutes.

- ▶ Wait for the rotor to stop before activating the emergency release.
 - ▶ To check, look through the monitoring glass in the centrifuge lid.
-

The emergency release consists of a cord with a plastic knob. The emergency release is located in the bottom panel at the front right device foot.

1. Disconnect the device from the mains/power supply.
2. Wait for the rotor to stop.
3. Push the centrifuge to the edge of the bench so that the bottom panel can be accessed from underneath at the front right device foot.
4. Remove the plastic button from the bottom panel.
5. Pull the cord downwards vertically.
The centrifuge lid opens.
6. To prepare the emergency release for its next use, push the cord all the way back into the housing.
7. Insert the plastic knob in the bottom panel.

Troubleshooting

Centrifuge 5702/5702 R/5702 RH
English (EN)

10 Transport, storage and disposal

10.1 Transport



CAUTION! Risk of injury due to lifting and carrying heavy loads.

The device is heavy. Lifting and carrying the device can lead to back injuries.

- ▶ Transport and lift the device with an adequate number of helpers.
- ▶ Use a transport aid to transport the device.

- ▶ Remove the rotor from the centrifuge before transport.
- ▶ Use the original packaging and the transport securing devices for transport.

	Air temperature	Relative humidity	Atmospheric pressure
General transport	-25 °C – 60 °C	10 % – 75 %	30 kPa – 106 kPa
Air freight	-20 °C – 55 °C	10 % – 75 %	30 kPa – 106 kPa

10.2 Storage

	Air temperature	Relative humidity	Atmospheric pressure
In transport packing	-25 °C – 55 °C	10 % – 75 %	70 kPa – 106 kPa
Without transport packing	-5 °C – 45 °C	10 % – 75 %	70 kPa – 106 kPa

10.3 Disposal

Observe the relevant legal regulations when disposing of the product.

Information on the disposal of electrical and electronic devices in the European Community:

Within the European Community, the disposal of electrical devices is regulated by national regulations based on EU Directive 2012/19/EU pertaining to waste electrical and electronic equipment (WEEE).

According to these regulations, any devices supplied after August 13, 2005, in the business-to-business sphere, to which this product is assigned, may no longer be disposed of in municipal or domestic waste. They are marked with the following symbol to indicate this:



As the disposal regulations may differ from one country to another within the EU, please contact your supplier for more information.

11 Technical data

11.1 Power supply

	5702	5702 R	5702 RH
Mains/power connection	230 V, 50 Hz – 60 Hz 120 V, 50 Hz – 60 Hz 100 V, 50 Hz – 60 Hz	230 V, 50 Hz – 60 Hz 120 V, 50 Hz – 60 Hz 100 V, 50 Hz – 60 Hz	230 V, 50 Hz – 60 Hz 120 V, 50 Hz – 60 Hz 100 V, 50 Hz – 60 Hz
Current consumption	1.2 A (230 V) 2.3 A (120 V) 2.4 A (100 V)	1.7 A (230 V) 3.3 A (120 V) 3.5 A (100 V)	1.7 A (230 V) 3.3 A (120 V) 3.5 A (100 V)
Power consumption	Maximum 200 W	Maximum 380 W	Maximum 380 W
EMC: Noise emission (radio interference)	230 V – EN 61326-1 / EN 55011 – Class B 120 V – CFR 47 FCC Part 15 – Class B 100 V – EN 61326-1 / EN 55011 – Class B	230 V – EN 61326-1 / EN 55011 – Class B 120 V: CFR 47 FCC Part 15 – Class A 100 V – EN 61326-1 / EN 55011 – Class A	230 V – EN 61326-1 / EN 55011 – Class B 120 V: CFR 47 FCC Part 15 – Class A 100 V – EN 61326-1 / EN 55011 – Class A
EMC: Noise immunity	EN 61326-1 – basic electromagnetic environment	EN 61326-1	EN 61326-1
Overvoltage category	II	II	II
Fuses	230 V 120 V 100 V	250 V 2.5 AT HBC 250 V 5.0 AT 250 V 5.0 AT	250 V 2.5 AT HBC 250 V 5.0 AT 250 V 6.3 AT HBC
Pollution degree	2	2	2

11.2 Ambient conditions

	5702	5702 R	5702 RH
Environment	For indoor use only.		
Ambient temperature	2 °C – 40 °C	10 °C – 40 °C	10 °C – 40 °C
Maximum relative humidity	75 %, non-condensing		
Atmospheric pressure	79.5 kPa – 106 kPa		

Technical data

Centrifuge 5702/5702 R/5702 RH
English (EN)

11.3 Weight/dimensions

	5702	5702 R	5702 RH
Width	32.0 cm	38.1 cm	38.1 cm
Depth	39.5 cm	58.1 cm	58.1 cm
Height	24.3 cm	27.0 cm	27.0 cm
Height with open lid	52.5 cm	59.5 cm	59.5 cm
Weight without rotor	18.8 kg	35.1 kg	35.1 kg
Rotor weights:		Accessories without caps:	
A-4-38	1230 g	Round bucket	190 g
		Rectangular buckets	140 g
A-8-17	1060 g		
F-45-24-11	660 g		
F-35-30-17	1150 g	Sleeve	30 g
F-45-18-17-Cryo	930 g		

11.4 Noise level

The noise level was measured according to (DIN EN ISO 3745) frontally in a sound measuring room with accuracy class 1 at a distance of 1 m from the device and at lab bench height.

	5702	5702 R	5702 RH
Noise level using rotor A-4-38	<52 dB (A)	<46 dB (A)	<46 dB (A)

11.5 Application parameters

	5702	5702 R	5702 RH
Run time	30 s – 99 min, infinite (∞) <ul style="list-style-type: none"> adjustable up to 10 min in 30 s increments, from 10 min in 1 min increments 	30 s – 99 min, infinite (∞) <ul style="list-style-type: none"> adjustable up to 10 min in 30 s increments, from 10 min in 1 min increments 	30 s – 99 min, infinite (∞) <ul style="list-style-type: none"> adjustable up to 10 min in 30 s increments, from 10 min in 1 min increments
Temperature	–	-9 °C – 40 °C	-9 °C – 42 °C
Relative centrifugal force	100 × <i>g</i> – 3000 × <i>g</i> <ul style="list-style-type: none"> can be set in increments of 100 × <i>g</i> 	100 × <i>g</i> – 3000 × <i>g</i> <ul style="list-style-type: none"> can be set in increments of 100 × <i>g</i> 	100 × <i>g</i> – 3000 × <i>g</i> <ul style="list-style-type: none"> can be set in increments of 100 × <i>g</i>
Rotational speed	100 rpm – 4 400 rpm <ul style="list-style-type: none"> can be set in increments of 100 rpm 	100 rpm – 4 400 rpm <ul style="list-style-type: none"> can be set in increments of 100 rpm 	100 rpm – 4 400 rpm <ul style="list-style-type: none"> can be set in increments of 100 rpm
Maximum load	4x100 mL	4x100 mL	4x100 mL
Maximum kinetic energy	2 280 J	2 280 J	2 280 J
Permitted density of the material for centrifuging (at max. <i>g-force</i> [rcf] or max. rotational speed [rpm] and max. load)	1.2 g/mL	1.2 g/mL	1.2 g/mL
Inspection obligation in Germany	no	no	no

Technical data

Centrifuge 5702/5702 R/5702 RH
English (EN)

11.6 Acceleration and deceleration times

The following table shows the acceleration and deceleration times for the rotors of the Centrifuge 5702/5702 R/5702 RH. All values given are reference values. Fluctuations may occur depending on the condition of the device and the load.

Rotor		Centrifuge 5702		Centrifuge 5702 R		Centrifuge 5702 RH	
			Soft ramp		Soft ramp		Soft ramp
A-4-38 with round buckets	Acceleration time	≤ 21 s	≤ 103 s	≤ 17 s	≤ 103 s	≤ 17 s	≤ 103 s
	Deceleration time	≤ 20 s	≤ 103 s	≤ 24 s	≤ 103 s	≤ 24 s	≤ 103 s
A-4-38 with rectangular buckets	Acceleration time	≤ 21 s	≤ 103 s	≤ 17 s	≤ 103 s	≤ 17 s	≤ 103 s
	Deceleration time	≤ 20 s	≤ 103 s	≤ 24 s	≤ 103 s	≤ 24 s	≤ 103 s
A-8-17	Acceleration time	≤ 15 s	≤ 103 s	≤ 15 s	≤ 103 s	≤ 15 s	≤ 103 s
	Deceleration time	≤ 19 s	≤ 103 s	≤ 19 s	≤ 103 s	≤ 19 s	≤ 103 s
FA-45-24-11	Acceleration time	≤ 15 s	≤ 103 s	≤ 15 s	≤ 103 s	≤ 15 s	≤ 103 s
	Deceleration time	≤ 19 s	≤ 103 s	≤ 19 s	≤ 103 s	≤ 19 s	≤ 103 s
F-35-30-17	Acceleration time	≤ 21 s	≤ 103 s	≤ 21 s	≤ 103 s	≤ 21 s	≤ 103 s
	Deceleration time	≤ 24 s	≤ 103 s	≤ 24 s	≤ 103 s	≤ 24 s	≤ 103 s

11.7 Service life of accessories



CAUTION! Danger due to material fatigue.

If the service life is exceeded, it cannot be guaranteed that the material of the rotors and the accessories will withstand the stresses during centrifugation.

- ▶ Do not use any accessories which have exceeded their maximum service life.

Eppendorf states the maximum service life of rotors and accessories both in years and in the maximum number of cycles. The decisive factor for the service life is which case occurs first, usually this is the number of years in operation.

Each centrifugation run during which the rotor is accelerated and braked is counted as a cycle, independent of the speed and the duration of the centrifugation run.

All other rotors and rotor lids can be used during the entire service life of the centrifuge if the following conditions are met:

- proper use
- recommended maintenance
- undamaged condition

Accessories	Maximum service life after first initial setup
Rotor lid of polycarbonate (PC), polypropylene (PP) or polyetherimide (PEI)	3 years
Aerosol-tight rotor lids without exchangeable seal	3 years or 50 autoclaving cycles, whichever occurs first
Aerosol-tight rotor lids with exchangeable seal (e.g., QuickLock rotor lids)	3 years (replace seals every 50 autoclaving cycles)
Non-aerosol-tight rotor lids	3 years
Aerosol-tight caps made of polycarbonate (PC), polypropylene (PP) or polyetherimide (PEI)	3 years or 50 autoclaving cycles, whichever occurs first
Adapter	1 year

The date of manufacture is stamped on the rotors and buckets in the format *03/15* or *03/2015* (= March 2015). On the inside of the plastic rotor lids and aerosol-tight caps, the date of manufacture is stamped in the form of a clock ⌚.

Measures to ensure aerosol tightness:

- ▶ Replace the seal of QuickLock rotor lids after 50 autoclaving cycles.
- ▶ Exchange aerosol-tight rotor lids without replaceable seals after 50 autoclaving cycles.
- ▶ Replace aerosol-tight caps after 50 autoclaving cycles.

Technical data

Centrifuge 5702/5702 R/5702 RH
English (EN)

12 Rotors, tubes and adapters



Eppendorf centrifuges may only be operated with rotors that are intended for use with the corresponding centrifuge.



- ▶ Only use rotors that are intended for use with the corresponding centrifuge.



Use only rotors labeled **Centrifuge 5702**, **Centrifuge 5702 R** or **Centrifuge 5702 RH**.



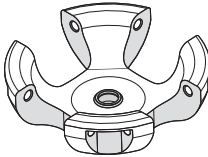
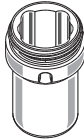



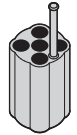

Please note the manufacturer's information on the centrifugation stability of the sample tubes used (maximum *g-force*).

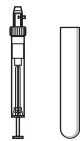
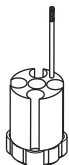

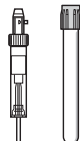

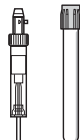



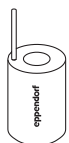
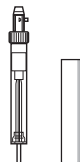
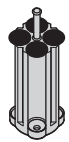



12.1 Rotor A-4-38

12.1.1 Rotor A-4-38 with 4 round buckets



			<table border="1" style="width: 100%;"> <tr> <td>Max. <i>g-force</i>:</td> <td style="text-align: right;">3000 × <i>g</i></td> </tr> <tr> <td>Max. speed:</td> <td style="text-align: right;">4400 rpm</td> </tr> </table>	Max. <i>g-force</i> :	3000 × <i>g</i>	Max. speed:	4400 rpm
Max. <i>g-force</i> :	3000 × <i>g</i>						
Max. speed:	4400 rpm						
Rotor A-4-38	Round bucket 5702 722.006 5702 761.001	Aerosol-tight cap 5702 721.000	Max. load per bucket (adapter, tube and contents): 190 g				



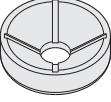



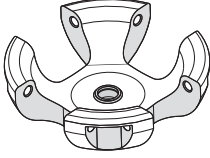

Tube	Tube Capacity Number per adapter/rotor	Adapter Order no. (international)	Bottom shape Tube diameter Max. tube length with/without aerosol-tight cap	Max. <i>g-force</i> Max. speed Radius
	Micro test tube 1.5 mL – 2 mL 4/16	 5702 745.006	Round Ø 11 mm 43 mm/43 mm	2900 × <i>g</i> 4400 rpm 13.4 cm
	Micro test tube 1.1 mL – 1.4 mL 5/20	 5702 736.007	Flat Ø 8.5 mm 100 mm/100 mm	2850 × <i>g</i> 4400 rpm 13.2 cm

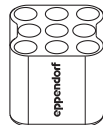

Tube	Tube Capacity Number per adapter/rotor	Adapter Order no. (international)	Bottom shape Tube diameter Max. tube length with/without aerosol-tight cap	Max. <i>g</i> -force Max. speed Radius
	Micro test tube 2 mL – 7 mL 5/20	 5702 737.003  5702 741.000	Flat Ø 12.5 mm 100 mm/100 mm	2850 × <i>g</i> 4400 rpm 13.2 cm
	Micro test tube 2.6 mL – 7 mL 4/16	 5702 719.005  5702 741.000	Flat Ø 13.5 mm 100 mm/100 mm	2850 × <i>g</i> 4400 rpm 13.2 cm
	Micro test tube 4 mL – 10 mL 4/16	 5702 735.000  5702 742.007	Flat Ø 16 mm 100 mm/100 mm	2850 × <i>g</i> 4400 rpm 13.2 cm
	Micro test tube 5 mL 1/4	 5702 733.008	Conical Ø 17 mm 60 mm/60 mm	2943 × <i>g</i> 4400 rpm 13.6 cm
	Micro test tube 9 mL – 15 mL 4/16	 5702 724.009	Round Ø 17.5 mm 100 mm/100 mm	2800 × <i>g</i> 4400 rpm 13.0 cm

Tube	Tube Capacity Number per adapter/rotor	Adapter Order no. (international)	Bottom shape Tube diameter Max. tube length with/without aerosol-tight cap	Max. <i>g</i>-force Max. speed Radius
	Micro test tube 15 mL 1/4	 5702 732.001	Conical Ø 17.2 mm 120 mm/121 mm	3000 × <i>g</i> 4400 rpm 13.7 cm
	Micro test tube 15 mL 2/8	 5702 723.002	Conical Ø 17.2 mm -/121 mm	3000 × <i>g</i> 4400 rpm 13.7 cm
	Micro test tube 25 mL 1/4	 5702 717.002	Round Ø 25 mm 100 mm/100 mm	2900 × <i>g</i> 4400 rpm 13.5 cm
	Micro test tube 25 mL 1/4	 5702 734.004	Conical Ø 30 mm 83 mm/83 mm	2900 × <i>g</i> 4400 rpm 10.7 cm
	Micro test tube 50 mL 1/4	 5702 734.004	Conical Ø 30 mm 115 mm/115 mm	2316 × <i>g</i> 4400 rpm 13.5 cm
	Micro test tube 50 mL 1/4	 5702 734.004	Conical Ø 30 mm 118 mm	2900 × <i>g</i> 4400 rpm 13.5 cm
	Micro test tube 100 mL 1/4	 5702 718.009	Round Ø 38 mm 106 mm/106 mm	2900 × <i>g</i> 4400 rpm 13.5 cm

12.1.2 Rotor A-4-38 with 4 rectangular buckets

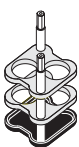



		Max. <i>g</i> -force:	2750 × <i>g</i>
		Max. speed:	4400 rpm
Rotor A-4-38	Rectangular buckets 5702 709.000 5702 762.008	Max. load per bucket (adapter, tube and contents):	240 g

Tube	Tube Capacity Number per adapter/rotor	Adapter Order no. (international)	Bottom shape Tube diameter Max. tube length	Max. <i>g</i> -force Max. speed Radius
	Micro test tube Cultivation vessel 5 mL 9/36	 5702 763.004	Round Ø 12 mm 75 mm	2577 × <i>g</i> 4400 rpm 11.9 cm
	Micro test tube 5 mL – 7 mL 10/40	 5702 710.008	Flat Ø 13 mm 100 mm	2750 × <i>g</i> 4400 rpm 12.7 cm
	Micro test tube 9 mL 8/32	 5702 711.004	Flat Ø 14.5 mm 100 mm	2750 × <i>g</i> 4400 rpm 12.7 cm
	Micro test tube 15 mL 6/24	 5702 712.000	Flat Ø 17.5 mm 100 mm	2750 × <i>g</i> 4400 rpm 12.7 cm
	Micro test tube 25 mL 2/8	 5702 716.006	Flat Ø 25 mm 100 mm	2750 × <i>g</i> 4400 rpm 12.7 cm

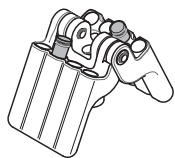
Tube	Tube Capacity Number per adapter/rotor	Adapter Order no. (international)	Bottom shape Tube diameter Max. tube length	Max. <i>g</i> -force Max. speed Radius
	Micro test tube 20 mL 4/16	 5702 713.007	Flat Ø 22 mm 100 mm	2750 × <i>g</i> 4400 rpm 12.7 cm







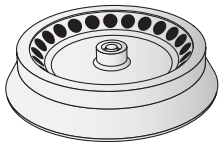

12.2 Rotor A-8-17

	Max. <i>g</i> -force:	2800 × <i>g</i>
	Max. rotational speed:	4400 rpm
Rotor A-8-17	Max. load per bucket (adapter, tube and contents):	38 g

Tube	Tube Capacity Number per adapter/rotor	Adapter Order no. (international)	Bottom shape Tube diameter Max. tube length	Max. <i>g</i> -force Max. rotational speed Radius
	Micro test tube 15 mL 1/8	 5702 702.005	Conical Ø 17.2 mm 120 mm	2 770 × <i>g</i> 4400 rpm 12.8 cm
	Micro test tube 15 mL 1/8	 5702 701.009	Round Ø 17.5 mm 120 mm	2 770 × <i>g</i> 4400 rpm 12.8 cm





12.3 Rotor F-45-24-11

	Max. <i>g</i> -force:	1770 × <i>g</i>
	Max. speed:	4400 rpm
F-45-24-11	Max. load per bucket (adapter, tube and contents):	8.70 g

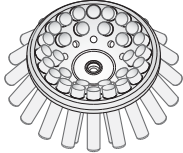
Tube	Tube Capacity Number per adapter/rotor	Adapter Order no. (international)	Bottom shape Tube diameter Max. tube length with/without rotor lid	Max. <i>g</i> -force Max. speed Radius
	Micro test tube 1.5/2 mL -/24	-	- Ø 11 mm	1770 × <i>g</i> 4400 rpm 8.2 cm
	PCR tube 0.2 mL 1/24	 5425 715.005	Conical Ø 6 mm	1 430 × <i>g</i> 4400 rpm 6.6 cm
	Micro test tube 0.4 mL 1/24	 5425 717.008	Conical Ø 6 mm	1770 × <i>g</i> 4400 rpm 8.2 cm
	Micro test tube 0.5 mL – 0.6 mL 1/24	 5425 716.001	- Ø 8 mm	1 600 × <i>g</i> 4400 rpm 7.5 cm
	Microtainers 0.6 mL 1/24	 5425 716.001	- Ø 8 mm 47 mm/64 mm	1 600 × <i>g</i> 4400 rpm 7.5 cm





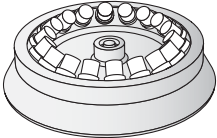

12.4 Rotor F-35-30-17

	Max. <i>g</i> -force:	2750 × <i>g</i>
	Max. speed:	4400 rpm
Rotor F-35-30-17	Max. load (adapter, tube and contents):	56 g

Tube	Tube Capacity Number per adapter/rotor	Adapter Order no. (international)	Bottom shape Tube diameter Max. tube length	Max. <i>g</i> -force
				Outer ring Center ring Inner ring Max. speed Radius Outer ring Center ring Inner ring
	Micro test tube 1.5 mL – 2 mL 1/10		Ø 11 mm	- - 1450 × <i>g</i> 4400 rpm - - 6.7 cm
	Micro test tube 15 mL 1/20	 5702 707.007 5702 706.000	conical Ø 16.2 mm	2750 × <i>g</i> 2300 × <i>g</i> - 4400 rpm 12.7 cm 10,7 cm -
	Micro test tube 15 mL 1/30	 5702 707.007 5702 708.003	round Ø 16.2 mm	2750 × <i>g</i> 2300 × <i>g</i> - 4400 rpm 12.7 cm 10,7 cm -

12.5 Rotor F-45-18-17-Cryo

	Max. <i>g</i> -force:	1970 × <i>g</i>
	Max. speed:	4400 rpm
F-45-18-17-Cryo	Max. load (adapter, tube and contents):	8.70 g

Tube	Tube Capacity Number per adapter/rotor	Adapter Order no. (international)	Bottom shape Tube diameter Max. tube length with rotor lid	Max. <i>g</i> -force Max. speed Radius
	Vessel with screw cap 1 mL – 2 mL -/17	–	flat Ø 17 mm 50 mm	1970 × <i>g</i> 4400 rpm 9.1 cm
	Cryo tube 1 mL – 2 mL 1/17	 5702 752.002	Ø 13 mm 50 mm	1930 × <i>g</i> 4400 rpm 8.9 cm
	Tube with lid 1/17	 5702 752.002	Ø 12.2 mm 50 mm	1930 × <i>g</i> 4400 rpm 8.9 cm
	HPLC vessel 1.5 mL 1/17	 5427 708.006	Ø 16.5 mm 50 mm	1930 × <i>g</i> 4400 rpm 8.9 cm

13 Ordering Information
13.1 Rotor A-4-38
13.1.1 Rotor A-4-38 with round buckets

Order no. (International)	Description
5702 720.003	Rotor A-4-38 with round buckets incl. 4 round buckets 100 mL
5702 761.001 5702 722.006	Round bucket 100 mL for rotor A-4-38 2 pieces 4 pieces
5702 721.000	Caps for 100 mL round buckets aerosol-tight 2 pieces
5702 745.006	Adapter for 4 tubes 1.5-2.0 mL 11 mm x 43 mm, for 100 mL round bucket in Rotor A-4-38 2 pcs.
5702 736.007	Adapter for 5 round-bottom tubes 1-1.4 mL, 8.5 mm x 100 mm for 100 mL round bucket in Rotor A-4-38 2 pcs.
5702 737.003	Adapter for 5 round-bottom tubes 2-7 mL, 12.5 mm x 100 mm for 100 mL round bucket in Rotor A-4-38 2 pcs.
5702 719.005	Adapter for 4 round-bottom tubes 2.6-7 mL, 13.5 mm x 100 mm for 100 mL round bucket in Rotor A-4-38 2 pieces
5702 735.000 5702 724.009 5702 732.001 5702 723.002 5702 717.002 5702 734.004 5702 718.009 5702 733.008	Adapter for 100 mL round bucket for use with standard and blood collection tubes, (number x tube volume, Ø adapter bore x max. tube length) 4 x 4 – 10 mL, 16 mm x 100 mm, set of 2 4 x 9 - 15 mL, 17.5 mm x 100 mm, set of 2 1 x 15 mL conical tube, 17.2 mm x 121 mm, set of 2 2 x 15 mL conical tubes, 17.2 mm x 121 mm, set of 2* 1 x 25 mL, 25 mm x 100 mm, set of 2 1 x 50 mL conical tube, 30 mm x 115 mm, set of 2 1 x 100 mL, 38 mm x 106 mm, set of 2 1 x 5 mL, 17 mm x 60 mm, set of 2
5702 741.000	Rubber mat for adapter 5702 737.003, 5702 719.005 7 mL, 20 pieces
5702 742.007	Rubber mat for adapter 5702 735.000 10 mL, 20 pieces

* Cannot be used with aerosol-tight caps.

Ordering Information

Centrifuge 5702/5702 R/5702 RH
English (EN)

13.1.2 Rotor A-4-38 with rectangular buckets

Order no. (International)	Description
5702 740.004	Rotor A-4-38 8 positions, max. Ø 38 mm without buckets
5702 762.008 5702 709.000	Rectangular bucket 90 mL for rotor A-4-38 2 pieces 4 pieces
5702 710.008 5702 711.004 5702 712.000 5702 713.007 5702 716.006 5702 763.004	Adapter for 90 mL rectangular bucket for use with standard tubes, (number × tube volume, Ø adapter bore × max. tube length) 10 × 5 – 7 mL, 13 mm × 100 mm, set of 2 8 × 9 mL, 14.5 mm × 100 mm, set of 2 6 × 15 mL, 17.5 mm × 100 mm, set of 2 4 × 20 mL, 22 mm × 100 mm, set of 2 2 × 25 mL, 25 mm × 100 mm, set of 2 9 × 5 mL, 12 mm × 100 mm, set of 2

13.2 Rotor A-8-17

Order no. (International)	Description
5702 700.002	Rotor A-8-17 8 Plätze, max. Ø 17 mm for 15 mL vessels
5702 702.005	Adapter for rotor A-8-17 for conical tubes 15 mL, 8 pieces
5702 701.009	Rubber mat for rotor A-8-17 15 mL round-bottom tubes, 8 pieces

13.3 Rotor F-45-24-11

Order no. (International)	Description
5702 746.002	Rotor F-45-24-11 45° angle, 24 places, max. Ø 11 mm without lid
5425 715.005	Adapter used in FA-45-48-11, F-45-48-11, FA-45-30-11, F-45-30-11, F-45-24-11, F-45-70-11, FA-45-24-11, FA-45-24-11-Special, FA-45-24-11-HS and FA-45-24-11-Kit for 1 PCR tube (0.2 mL, max. Ø 6 mm), set of 6
5425 717.008	Adapter used in FA-45-48-11, F-45-48-11, F-45-12-11, FA-45-18-11, FA-45-30-11, F-45-30-11, F-45-24-11, F-45-70-11, FA-45-24-11-HS, FA-45-24-11-Kit and S-24-11-AT for 1 micro test tube (0.4 mL, max. Ø 6 mm), set of 6
5425 716.001	Adapter used in FA-45-48-11, F-45-48-11, FA-45-30-11, F-45-30-11, F-45-48-11, F-45-70-11, FA-45-24-11, FA-45-24-11-Special, FA-45-24-11-HS and FA-45-24-11-Kit for 1 sample tube (0.5 mL, max. Ø 6 mm) or 1 Microtainer (0.6 mL, max. Ø 8 mm), set of 6

13.4 Rotor F-35-30-17

Order no. (International)	Description
5702 704.008	Rotor F-35-30-17 35° angle, 30 places, max. Ø 17 mm incl. 30 steel sleeves for 15 mL vessels, 20 Adapters for conical tubes and 30 rubber mats
5702 705.004	incl. 10 steel sleeves for 15 ml vessels, 10 Adapters for conical tubes and 10 rubber mats
5702 707.007	Steel sleeve for rotor F-35-30-17 15 mL, 10 pieces
5702 706.000	Adapter used in F-35-30-17 for conical tubes 15 mL, 10 pieces
5702 708.003	Rubber mat for rotor F-35-30-17 15 mL round-bottom tubes, 10 pieces

Ordering Information

Centrifuge 5702/5702 R/5702 RH
English (EN)

13.5 Rotor F-45-18-17-Cryo

Order no. (International)	Description
5702 747.009	Rotor F-45-18-17-Cryo angle 45°, 18 places, max. Ø 17 mm, max. length 50 mm for cryo tubes and sealable centrifugation tubes, without rotor lid, without adapter
5702 752.002	Adapter used in F-45-18-17-Cryo for cryo tubes (max. Ø 13 mm) and sealable centrifuge tubes (max. Ø 12.2 mm), max. length 50 mm, set of 6
5427 708.006	for 1.5 mL HPLC vials, 18 pieces

13.6 Fuses

Order no. (International)	Description
5425 351.003	Fuse 2.5 A T (230 V), set of 2
5425 353.006	5 A T (100V/120 V), UL, set of 2
5703 851.136	6.3 AT (100 V), 2 pieces

Declaration of Conformity

The product named below fulfills the requirements of directives and standards listed. In the case of unauthorized modifications to the product or an unintended use this declaration becomes invalid. This declaration of conformity is issued under the sole responsibility of the manufacturer.

Product name:

Centrifuge 5702, Centrifuge 5702 R, Centrifuge 5702 RH

including components

Product type:

Centrifuge

Relevant directives / standards:

2017/746/EU: DIN EN ISO 13485, DIN EN ISO 18113-1, DIN EN ISO 18113-3, DIN EN ISO 15223-1, DIN EN ISO 14971, DIN EN 61010-2-101, DIN EN 61326-2-6, DIN EN 62366-1

2014/35/EU: DIN EN 61010-1, DIN EN 61010-2-010 (only 5702 RH), DIN EN 61010-2-020

2014/30/EU: DIN EN 61326-1, DIN EN 55011

2011/65/EU: DIN EN IEC 63000
(incl. (EU) 2015/863)

Further applied standards: IEC 61010-1 + Cor. + A1 + A1/Cor.1, IEC 61010-2-010, IEC 61010-2-020, IEC 61010-2-101
UL 61010-1, UL 61010-2-020
CAN/CSA C22.2 No. 61010-1-12, CAN/CSA C22.2 No. 61010-2-020
IEC 61326-1, CISPR 11 + A1, 47 CFR FCC part 15
YY/T 0657, GB 4793.1, GB 4793.7, GB 18268.1, YY/T 0466.1, SJ/T 11364, GB/T 26572

Basic UDI-DI: 04043758-IA-CEN-005-P4

Hamburg, November 08, 2021



Dr. Wilhelm Plüster
Management Board



Dr. Marlene Jentzsch
Senior Vice President
Division Separation & Instrumentation

Your local distributor: www.eppendorf.com/contact
Eppendorf SE · Barkhausenweg 1 · 22339 Hamburg · Germany
eppendorf@eppendorf.com

Eppendorf® and the Eppendorf Brand Design are registered trademarks of Eppendorf SE, Germany. All rights reserved, incl. graphics and pictures. Copyright ©2021 by Eppendorf SE.

ISO
9001
Certified

ISO 13485
Certified

ISO 14001
Certified

CERTIFICATE OF COMPLIANCE

Certificate Number 2018-6-22-E215059
Report Reference E215059-D1005-1/A0/C0-UL
Issue Date 2018-6-22

Issued to: EPPENDORF AG
Applicant Company: BARKHAUSENWEG 1
22339 HAMBURG
GERMANY

Listed Company: Same as applicant

**This is to certify that
representative samples of** Centrifuge
5702

Have been investigated by UL in accordance with the
Standard(s) indicated on this Certificate.

Standard(s) for Safety: UL 61010-1, 3rd Edition, May 11, 2012, Revised April 29 2016,
CAN/CSA-C22.2 No. 61010-1-12, 3rd Edition, Revision dated
April 29 2016

Additional Standards: IEC 61010 2-020: 2016 (Third Edition) for use in combination
with IEC 61010 1:2010 (Third Edition)

Additional Information: See the UL Online Certifications Directory at
www.ul.com/database for additional information.

Only those products bearing the UL Certification Mark should be considered as being covered by UL's
Certification and Follow-Up Service.

Look for the UL Certification Mark on the product.

This is to certify that representative samples of the product as specified on this certificate were tested
according to the current UL requirements.

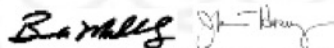

Bruce Mahrenholz, Assistant Chief Engineer, Global Inspection and Field Services, UL LLC
Joseph Hosey, General Manager, Director of Sales – Canada, UNDERWRITERS LABORATORIES OF CANADA INC.

Any information and documentation involving UL Mark services are provided on behalf of UL LLC (UL) or any authorized licensee of UL. For questions, please contact a local UL
Customer Service Representative www.ul.com/contactus



CERTIFICATE OF COMPLIANCE

Certificate Number 20120914- E215059
Report Reference E215059-20120914
Issue Date 2012-SEPTEMBER-14

Issued to: EPPENDORF ZENTRIFUGEN GMBH
RIESAER STR 198
04319 LEIPZIG GERMANY

**This is to certify that
representative samples of**

LABORATORY-USE ELECTRICAL EQUIPMENT
Laboratory Centrifuge 5702R, 5703, 5702RH, 5704

Have been investigated by UL in accordance with the
Standard(s) indicated on this Certificate.

Standard(s) for Safety:

UL 61010-1 (Electrical Equipment for Measurement,
Control, and Laboratory Use; Part 1: General
Requirements)
CAN/CSA-C22.2 No. 61010-1 (Electrical Equipment for
Measurement, Control, and Laboratory Use; Part 1: General
Requirements)

Additional Information:

See the UL Online Certifications Directory at
www.ul.com/database for additional information

Only those products bearing the UL Listing Mark for the US and Canada should be considered as being covered by UL's Listing and Follow-Up Service meeting the appropriate requirements for US and Canada.

The UL Listing Mark for the US and Canada generally includes: the UL in a circle symbol with "C" and "US" identifiers:  the word "LISTED"; a control number (may be alphanumeric) assigned by UL; and the product category name (product identifier) as indicated in the appropriate UL Directory.

Look for the UL Listing Mark on the product.



William R. Carney, Director, North American Certification Programs

UL LLC

Any information and documentation involving UL Mark services are provided on behalf of UL LLC (UL) or any authorized licensee of UL. For questions, please contact a local UL Customer Service Representative at www.ul.com/contactus



© CAMR The contents of this report may not be abstracted, published or used for advertising without permission.

Containment Testing of the Sealed Buckets For The A-4-38 Rotor in the Eppendorf 5702 Bench Top Centrifuge

Report 769/02

Commercial in Confidence

CAMR Ref.	Project No. 769/02
Customer Ref.	620-804158
Report Prepared For	Ms. Sylke Grun
Operator	Ms Carolyn Budge
Issue Date	27th August 2002
Number of Copies	1
Distribution	Ms. S Grun, Mr. A. Bennett, Central Records (Dr. P. Hammond)

Report Checked By



Name Ms. Sara Speight
Title Research Scientist

Authorised And Written By



Name Mr Allan Bennett
Title Head of Biosafety Investigation Unit

Evaluate Your Manual

Give us your feedback.
www.eppendorf.com/manualfeedback



Eppendorf SE
Barkhausenweg 1
22339 Hamburg
Germany

Your local distributor: www.eppendorf.com/contact
eppendorf@eppendorf.com · www.eppendorf.com